

**Fundamental investigations on the barrier effect of polyester micro fiber
fabrics towards particle-loaded liquids induced by surface
hydrophobization**

Der Fakultät Maschinenwesen
Der Technischen Universität Dresden

zur

Erlangung des akademischen Grades
Doktoringenieur (Dr.-Ing.)
vorgelegte Dissertation

Md. Nazirul Islam
aus Bangladesh

Tag der Einreichung: 24.09.04

Gutachter: Prof. Dr. - Ing. habil. Dr. h. c. Peter Offermann
Prof. Dr. rer. nat. habil. Brigitte Voit
Prof. Dr.-Ing. Siegfried Ripperger

ACKNOWLEDGEMENTS

I begin my thanking and applauding my research supervisor Prof. Dr. Brigitte Voit for giving me the opportunity to be a proud member in her research group. Her guidance, insight and encouragement were indispensable during all aspects of this research, and without these I could not successfully complete my work. I had the keen pleasure working under her supervision not only for her scientific leadership, but even more for her genuine concern for my entire works.

I express my profound gratitude to Prof. Dr. Peter Offermann, whose kind acceptance to be my supervisor allowed me to embark on this journey. His suggestions, hints and overall backing also helped me to a large extent to reach the final goal.

I would like to convey my sincere thanks to Dr. Uwe Lappan, whom I have had the good fortune of knowing since first day of this research. When there was a problem, even if tricky, he extended his helpful hands without the least hesitation. In fact, he was always with me like a shadow during the whole working period.

I am also specially thankful to Dr. Carsten Werner for his supervision and technical support in designing and performing the barrier tests of the modified fabrics.

Many co-workers of the IPF of different departments, who contributed to this work by conducting measurements and by assisting me in the evaluation of the results deserve my gratitude: Dr. Frank Simon, Dr. Joachim Oswald, Dr. Victoria Dutschk, Dr. Klaus-Jochen Eichhorn, Mrs. Steffi Uhlmann, Mrs. Gudrun Adam, Mrs. Martina Franke, Mr. Roland Schulze, Mr. Heinz Körber.

I am particularly indebted to Dr. R.-D. Hund, for his excellent knowledge and understanding of the wet-processing, with which I was able to clear many roadblocks.

By far the most satisfying aspect of this experience has been the enjoyment of working (and playing) with so many terrific people along the way. Naming all of you here might actually prevent my being able to finish what writing I have yet to complete, so I don't dare try! You know who you are.

I must thank for that handful of very special people of whom life has seemingly made gifts to me. My family means the world to me, and I appreciate this today more than ever. I especially thank my parents, whose guidance and caring have been beyond words.

Finally, this project would not have been possible without the financial support by Deutsche Forschungsgemeinschaft (DFG), which is greatly acknowledged.

CONTENTS

1.	INTRODUCTION	1
2.	THEORY	4
2.1	Polyester	4
2.1.1	General constitution.....	4
2.1.2	Polyester fiber.....	5
2.1.3	Polyester micro fiber.....	8
2.2	Hydrophobization	10
2.2.1	Wet-finishing.....	11
2.2.1.1	<i>Fluorocarbon</i>	11
2.2.1.2	<i>Silicone</i>	13
2.2.2	Plasma modification.....	16
2.2.2.1	<i>Low-pressure plasma</i>	18
2.2.2.2	<i>Advantages and disadvantages of plasma treatment</i>	19
2.2.2.3	<i>Plasma fluorination</i>	20
2.3	Wetting Behavior of Textiles	23
2.3.1	Contact angle.....	23
2.3.2	Sliding angle.....	26
2.4	OP textiles	28
2.4.1	Overview.....	28
2.4.2	Barrier effect.....	29
2.4.3	General requirements.....	31
3.	OBJECTIVE	33
4.	RESULTS AND DISCUSSION	36
4.1	Wet-Finishing	36
4.1.1	Selection of appropriate hydrophobic agents.....	36
4.1.2	Optimization of the application conditions.....	39
4.1.3	Influencing factors other than the application parameters.....	42
4.1.3.1	<i>Wetting agent</i>	43
4.1.3.2	<i>Fluorine content</i>	44
4.1.3.3	<i>Regenerating treatment after washing</i>	45
4.1.3.4	<i>Ironing of the fabric</i>	47
4.1.3.5	<i>Alkali treatment of the surface</i>	49
4.1.4	Optimization results of wet-finishing agents.....	50

4.2	Plasma Modification	53
4.2.1	Treatment with C ₂ H ₄ plasma.....	53
4.2.2	Treatment with CF ₄ plasma.....	54
4.2.3	Treatment with C ₂ F ₆ plasma.....	55
4.2.4	Treatment with H ₂ /C ₂ F ₆ plasma.....	56
4.2.5	Treatment with C ₂ H ₄ /C ₂ F ₆ plasma.....	58
4.2.6	Influence of surface structure on plasma modified surfaces.....	61
4.3	Physico-Chemical Characterization	63
4.3.1	Washing permanence.....	63
4.3.2	Air permeability.....	65
4.3.3	Ageing properties.....	66
4.3.4	Tensile strength.....	67
4.3.5	XPS-analysis.....	69
4.3.6	FTIR(ATR)-measurements.....	75
4.3.7	Thickness of plasma polymers.....	77
4.3.8	Surface topography.....	78
4.4	Evaluation of Barrier Properties	81
4.4.1	Absorption of synthetic blood.....	82
4.4.2	Absorption of protein solution.....	83
4.4.3	Absorption of human blood.....	85
5.	SUMMARY	88
6.	OUTLOOK	93
7.	EXPERIMENTAL	94
7.1	Materials	94
7.2	Pre-Treatment	96
7.3	Hydrophobic Treatment	99
7.3.1	Wet-finishing.....	99
7.3.1.1	<i>Chemicals</i>	99
7.3.1.2	<i>Methodology</i>	100
7.3.2	Plasma modification.....	101
7.3.2.1	<i>Equipment</i>	101
7.3.2.2	<i>Process gas</i>	102
7.3.2.3	<i>Treatment procedure</i>	102
7.4	Evaluation	104
7.4.1	Degree of hydrophobicity.....	104
7.4.2	Durability.....	105
7.4.3	Air permeability.....	106
7.4.4	Tensile strength.....	107
7.5	Surface Analysis	108
7.5.1	FTIR-spectroscopy.....	108
7.5.2	XPS.....	108
7.5.3	Ellipsometry.....	110
7.5.4	REM.....	111

7.6	Evaluation of Barrier Effect	113
7.6.1	Test liquids.....	113
7.6.2	Absorption test.....	114
7.6.3	Colorimetric evaluation.....	115
8.	LIST OF SYMBOLS AND ABBREVIATIONS	117
9.	REFERENCES	119

1. INTRODUCTION

Hospital infection is, at large, the bacterial or viral infection which develops during the patient stay at hospital or soon after its leaving¹. The total statistical figure of patients in today's world acquiring infections during their hospital stay is frightening. The underlying reasons for that are complex but some of the key factors are thought to be²:

- Lack in absolutely guaranteed barrier materials in operations.
- The emergence of antibiotic resistant bacteria.
- Increased number of vulnerable patients.

One of the vehicles by which the infections can be transmitted around health care institutions, in particular, in operating room from carer to patient or vice versa is the blood coming out from the patient's body during operation, other common gangway being contact, respiratory or aerobic infections. To overcome these critical situations, polymer scientists, physicist, doctors and textile researchers have joined hands in conducting the required advanced multi-disciplinary experiments. There are, however, several concerned efforts that have already been realized with limited degree of satisfaction³ and various are underway.

Textiles are no more restricted for apparel use only. Due to the growing awareness of, and demand for, secured protection against clinical hazards coupled with comfortness, particularly in developed nations, the traditional apparel market is moving towards high value added product segments, e.g., in medical uses⁴. They are finding such an innovative application in today's healthcare environment, which were not imaginable just a few years ago.

The range of textile products available for healthcare and hygiene is vast, but they are typically used either in operating room or in hospital wards for hygiene, care and safety both for patients and staff. They could be washable or disposable. Among available variants of barrier textiles, reusable surgical gowns are experiencing phenomenal growth due to critical reassessment of clinical practices for improved clinical hygiene and need for advanced materials for better healthcare at lower cost.

Absolute secureness and comfort characteristics being two general and predominant parameters for a barrier fabric, the improved bioclimatic and physiological properties are also of increasing demands, such as^{4,5}

- Durability.
- Breathability.
- Thermoregulatory characteristics.
- Ease of laundering, sterilization and antistatic behavior.
- Low level of textile chemicals and dyes with high mechanical stability.

Polyester micro fiber, a glorious invention of the last decade, can provide the above attributes far better than the conventional textile materials used for medical applications which are unable to cope with high cost of production and modernization as well as obsolescence. The importance of micro fibers in medical fields as barrier clothing is credited to their compact fabric structure characterized with excellent physical properties, such as strength, flexibility, suppleness, air and moisture permeability and wicking⁶. Due to their revolutionary merits they have already established strong potential to offer an opportunity for being a good alternative for classical textile materials.

Apart from the material side, which is crucial, is the extent and method of conferring barrier properties to the fabric. Barrier characteristic, i.e., the ability to reject the hazardous pathogens of different dimensions and constructions such as bacteria, virus is to be realized generically in two ways:⁷

- Passive barrier.
- Active barrier.

Passive barrier effects are achieved without application of special substances or surface modification techniques. Fiber surfaces that are rough on a nanometer scale tend to be more hydrophobic than smooth surfaces because of the reduced contact area between the water and solid – e.g., in the lotus plant the actual contact area is only 2 – 3 % of the droplet-covered surface⁸. Due to the very small interfacial area between particle and rough surface, adhesion is minimized. Therefore, the water droplets roll-off the fabric surface even for a slight fluctuation of the position held.

Actively finished or modified materials contain definite water-repellent groups, which will not allow the adhesion of the particle-loaded liquids on their surfaces because of a low surface energy of the functional moieties incorporated. Thus, they will impose a chemical barrier against blood-borne microorganisms, dirt and other foreign bodies, whilst the first technique is typically featured with mechanical action. The way of incorporation of chemical functionalities on the surface can be broadly categorized in three groups^{7,9}:

- The addition of active substance to the spin mass directly.
- The application of hydrophobic chemicals on the finished fabric.
- Surface modification by grafting or other chemical reactions.

If an appliance is added at the spinning stage of fiber, it appears to be more stable than the others applied at any later phase of the material. It suffers, however, from somewhat inflexibility of the process, whereas finishing the material in a subsequent state represents a more adaptable method, which may take place either at yarn or fabric stage. The further possibility, involving chemical reactions at the topmost layer of the material calls increasingly attention for modifying surface characteristics without affecting the general properties of the bulk.

2. THEORY

2.1 Polyester

2.1.1 General constitution

Polyesters are heterochain macromolecular substances characterized by the presence of carboxylate ester groups distributed either regularly or randomly along the main polymer chain (hence polyester)¹⁰.

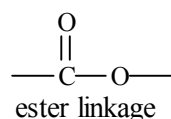

Esters are formed when alcohol reacts with a carboxylic acid:

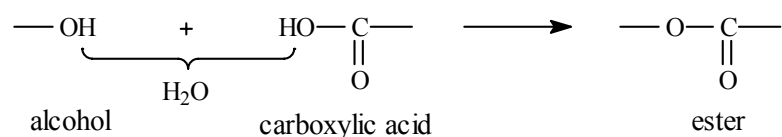

Polyesters are generally obtained through the multiple linking of polyalcohol with dicarboxylic acids (or their derivatives, e.g., diesters or dichlorides). The presence of two functional groups of each reacting components results in the formation of a linear molecule¹¹:

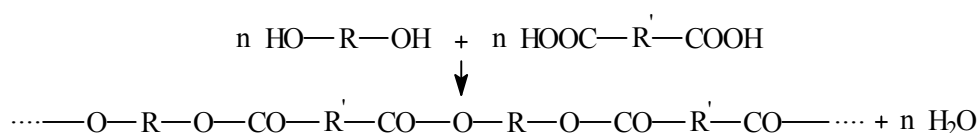

If one of the two reacting partners contains more than two functional groups, cross linked polyesters are formed. The result is that even after two functional groups react to form linear polyester, one functional group remains. Reaction of these additional groups forms the cross link between the polymer chains¹¹. For example:

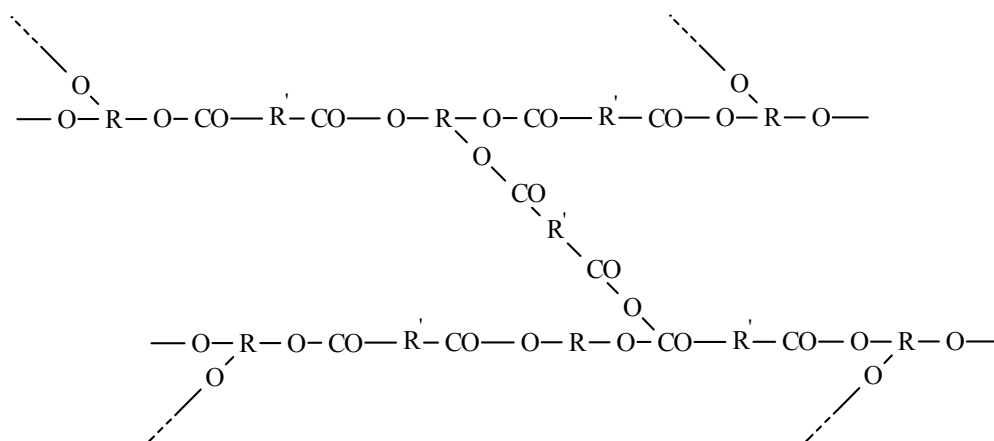

Polyester can also be derived from the self-condensation of hydroxyl group containing dicarboxylic acid:

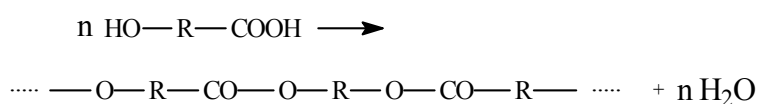

The name of polyester refers to the linkage of several esters within the polymer main chain. This is why, many types of polymers possessing esters as pendant groups in the side chains (e.g., cellulose ester, polyvinyl acetate, polyacrylates etc.) do not belong to the class of polyesters.

2.1.2 Polyester fiber

Linear polyesters can be classified as aliphatic, partly aromatic, or aromatic polyesters. By far the most commercially important of the polyesters is a partly aromatic polyester, more specifically poly(ethylene terephthalate), often referred to as PET introduced commercially in 1953 as a textile fiber¹².

As defined by the Federal Trade Commission of USA¹³¹ PET fiber is a manufactured fiber in which the fiber forming substance is any long-chain synthetic polymer composed of at least 85% by weight of an ester of a substituted aromatic carboxylic acid, including but not restricted to substituted terephthalic units, $p(-\text{R}-\text{O}-\text{CO}-\text{C}_6\text{H}_4-\text{CO}-\text{O}-)_x$ and para substituted hydroxy-benzoate units, $p(-\text{R}-\text{O}-\text{CO}-\text{C}_6\text{H}_4-\text{O}-)_x$.

Industrially the polyethylene terephthalate (PET) is prepared in high molecular weight on the basis of reaction of ethylene glycol (EG) with either dimethyl terephthalate (DMT) or purified terephthalic acid (PTA), using generally two successive stages. In the first stage a polyester precondensate, a mixture of ethylene glycol esters of terephthalic acid (M_n 100-2000 g/mol, depending on the molar ratio of the starting compounds) is produced either by ester

interchange or by direct esterification methods¹³. The precondensate then is subjected to a further step (i.e., polycondensation) that produces poly (ethylene terephthalate) of fiber forming polymer weight ($M_n > 10,000$ g/mol)¹⁴⁻¹⁶.

1st step: Esterification

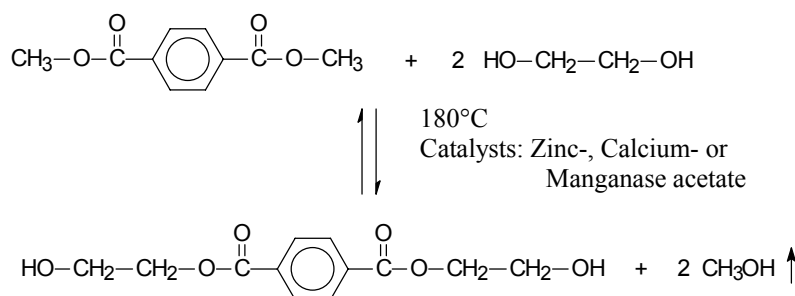

2nd step: Polycondensation

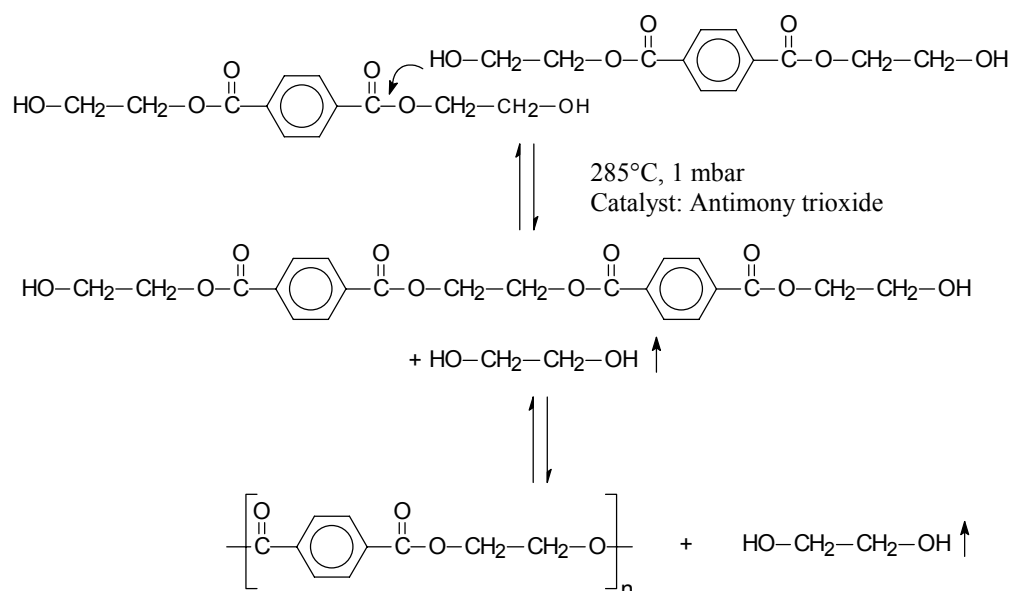

PET, an aliphatic-aromatic polymer composition, is rigid in structure. The two carbonyl functions together with the aromatic ring provide structural rigidity of the macromolecule;

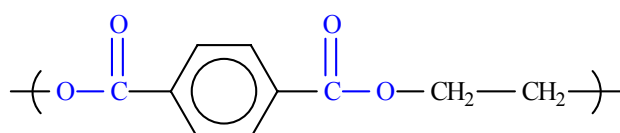

The polar ester groups in poly(ethylene terephthalate) hold the polyester into strong crystals.

little flexibility arises due to the presence of the ethylene group in the repeat unit. The aromatic, carboxyl, and aliphatic molecular groups are nearly planer in configuration and

exist in side-by-side arrangement. Distances between the atoms in neighboring molecules are all normal van der Waals contact distances, and there is no structural evidence for any unusually strong forces between the molecules. The higher melting temperature of PET than that of aliphatic polyester is therefore not due to any strong forces between the molecules, but is attributed to the rigidity of the aromatic group and ester linkage^{18,19}.

The molecular structure of PET-fibers can be described as two-phase structure consisting of crystalline and non-crystalline regions²⁰. The orientation of the polymer chains in the non-crystalline phase, which can be seen as the weak link of the structure, is one of the most important features that determines the mechanical properties as well as the dyeing behavior of the material. The PET-fibers are approximately 35% crystalline and 65% amorphous²¹. But the proportion of these regions in a particular fiber often varies with the processing parameters of that fiber, which also impart to the fiber more crystalline and less crystalline regions with different degree of orientation.

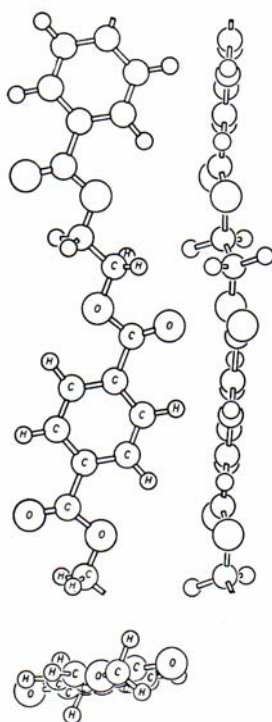

Figure 1 Crystal structure of polyethylene terephthalate¹³².

The merits of polyester fibers are their relatively high melting and glass transition temperatures, insensitivity to moisture and common solvents, and the wide range of mechanical properties attainable by various molecular weight, orientation, and crystallinity, giving characteristics suitable at one extreme for uses in apparel, curtains, upholstery, fiberfill and at the other, for medical applications such as operation clothing.

2.1.3 Polyester micro fiber

Micro fibers are being increasingly important due to their excellent hand-feel and aesthetic characteristics. Up to now there is no generally accepted definition for micro fibers. But normally the term is linked to the fiber diameter and/or weight/ length of filament in dtex or denier and not with any properties of the fiber. Due to the fact that cross section of fibers is not exclusively circular, the diameter should not be used for characterization of fiber fineness. The most accepted definition for micro fibers seems to be a fiber with 1 dtex in maximum.



Figure 2 Polyester micro fiber.

The unit dtex or decitex means the weight in decigram per kilometer; that is, if a filament having a length of one kilometer weighs only one decigram (0.1 gram), its fineness is expressed as one decitex. The most widely used man-made fibers/filaments, for example polyester, nylon, acrylic, lyocell etc., range from one to five decitex whereas the micro fibers have always less than one.

There are two different conceptions about the definition of micro fibers with little difference in the different parts of the world. In Japan and North America the convention is to define micro fibers as having a fineness less than 1.0 denier equivalent to 1.1 decitex. In Western Europe and the rest of the world they are accepted as the filaments having a decitex of less than 1.0²⁴.

By means of conventional melt spinning process, polyester continuous-filament micro fibers of linear densities down to 0.4 dtex have been produced. Such type of production demands extra attention to polymer quality and filtration, since smaller openings of the spinneret are required to be used in order to keep the spin-stretch ratio from becoming too high. Besides, the total extrusion time is higher in this case, and because of extra melt residence time, they can lead to greater thermal degradation of the polymer¹⁶.

Table 1 Fiber classification depending on their count^{22,23}.

Fiber count (dtex)	Fiber classification
> 7.0	Coarse
7.0-2.4	Medium fine
2.4-1.0	Fine
1.0-0.3	Micro
<0.3	Super micro

The smaller the diameter, the softer the fabric will feel. The fabrics made from these extra-fine fibers provide a gentle drape and incredible softness. Resilience, lightweight and user-friendly properties have made micro fiber apparel a growth industry in recent years. Active sportswear, waterproof rainwear and medical textiles of better quality can also be made from them. It has been found that micro porous fabrics made of micro fibers for surgeons and operation staff decrease high risk of post-operative infections in patients.

The little disadvantages of micro fibers lie in their production cost and the processing difficulties into yarn, fabric and in dyeing-finishing with the existing systems. Extensive scientific works have been carried out to avoid these limitations considering the voluminous market demand of micro fibers.

2.2 Hydrophobization

The term “hydrophobic” literally originates from the Greek one: hydro means “water” and phobic stands for “fear”. Therefore, hydrophobicity can be defined as water-repellent or water-avoiding effect²⁵.

Prevention of polar liquids from penetrating the outer shell of a fabric can be achieved in various ways²⁶:

- Making the surface water-resistant by structural design
- Sealing the fabric, i.e., giving a water-proof finish
- Introducing surface hydrophobicity by chemical modification

Water-resistant fabrics shed water because of their weave or surface pattern. However, they will soak through in a heavy rain. Waterproof fabrics cannot be penetrated by water and should keep us dry. They are, in general, finished by coating or lamination. Fabrics so treated lose their porosity and lightness, while a water repellent fabric does not. In general, hydrophobic fabrics are those which resist being wetted by water, water drops will roll off the fabric, but the fabrics tend to remain porous and to retain their natural characteristics²⁷.

Nowadays there are different techniques available to confer hydrophobic surface. Until the alluring turn of the chemical technology, precipitation of aluminium salts of fatty acids on the fabric and treatment with emulsion of paraffin waxes²⁸ found widespread use for hydrophobic modification. These were later replaced by finishing with higher alkyl chains containing fiber-reactive compounds²⁹. In the 1950's the silicone polymers^{7,30} found a wide field of application. In the past decade the perfluoro compounds^{31,32} have been extensively used for hydrophobic treatment.

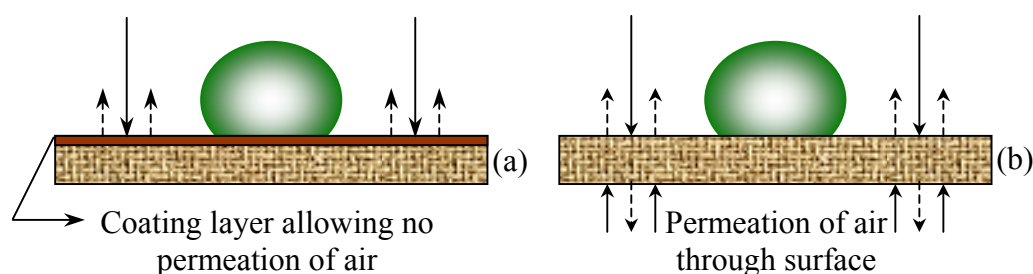

Figure 3 Inhibition of water penetration through the fabric surface by depositing an impermeable layer (a) or making it hydrophobic (b).

More recently, there has been increased interest in the use of plasma technology^{33,34} for surface modification of textile materials as a challenging alternative to wet-chemical methods considering economic and environmental aspects.

The principle of the action of all these hydrophobic treatments on various fibrous materials is the same: increase of contact angle of liquids, in general water, on the surface of the fiber. Hydrophobic fibers like polyester exhibit higher contact angles than cellulose, but not high enough for satisfactory water-repellency²⁹. Therefore, they are needed to be finished, not only to reduce the wetting behavior showing a higher contact angle, but also to confer a corresponding sliding angle³⁵ that ascertain the running off ability of the water droplet from a inclined surface in a similar manner to drops of mercury on a surface which is not amalgamated by the mercury.

2.2.1 Wet-finishing

2.2.2.1 Fluorocarbon

For hydrophobic treatment, fluorocarbons are being used as most effective chemicals till today. Not all fluorocarbons do have water repellent effects, but certain types such as chromium complexes of saturated perfluorocarboxylic acids, chromium complexes of perfluoroalkylmonocarboxylic acids, and various fluorinated acrylic and methacrylic esters^{37,38} do confer water-repellency.

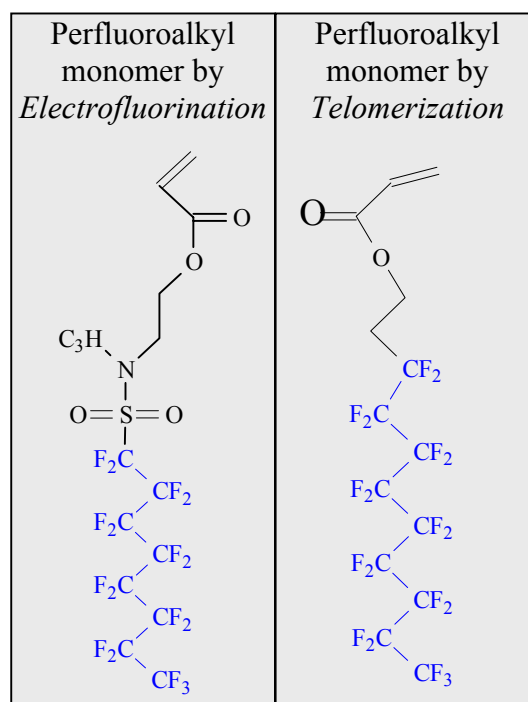

Figure 4 Monomers designed for polymerization of fluorocarbon⁴¹.

The fluorochemical repellents used for textiles are mostly copolymers of fluoroalkyl acrylates and methacrylates³⁹. The comonomers are esters of acrylic and methacrylic acids containing a variety of alkyl and substituted alkyl groups chosen to modify the physical properties of the polymers, to improve performance, and to reduce cost.

The molecules of all fluorochemical repellents consist of two fractions: the fluorinated and the non-fluorinated part⁴⁰. The fluorinated part, called the perfluoroalkyl group, composed of carbon atoms linked to other carbon atoms forming the core; attached and surrounding each carbon atom by fluorine atoms forming a sheath. These fluorine atoms act like little umbrellas in a rain shower.

In practice, the fluorochemical portion is manufactured by two well-known methods, which also result in two different types of perfluoroalkyl monomer^{41,42}:

- Electrochemical fluorination and
- Telomerization

The electrochemical fluorination produces acrylic acid derivative of perfluoroalkyl sulfone amide, by applying the latter an acrylate ester of perfluoroalkyl ethyl is received.

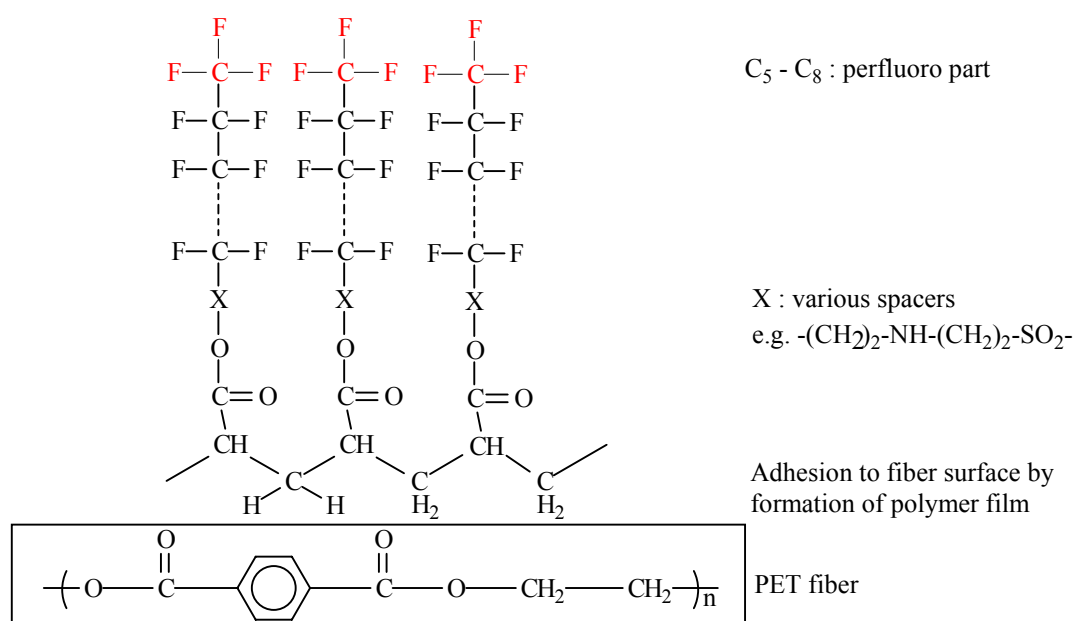

Figure 5 Fundamental construction of acrylate base fluorocarbon polymer.

The fluorochemical part produced by either method is chemically anchored with a non-fluorinated part, which can be acrylic, vinyl or urethane. The non-fluorinated part serves two other purposes: it forms a backbone to the fluorochemical making it more durable and acts as a bridge to bond the fluoro-chemical moieties to the fiber. The perfluoro segments being grafted onto this polymer backbone are arranged on the fiber surface assuming a brush-like

structure⁴³ which causes the low surface energy of the treated fabric. Heat facilitates the orientation by increasing molecular motion.

Fluorochemicals are often used with spacers, which may be other repellents such as the resin-based types or even materials normally used as softeners⁴⁴. With the spacers the amount of fluorochemical required could often be reduced by 50 % or more resulting in greatly improved economics⁴⁵.

The hydrophobic ability of fluorochemicals largely depends on the length of perfluoro segment. Research studies in fluorochemistry⁴⁶ have shown that the greater the number of fluorine atoms attached to the carbon atoms, and the more closely packed they are, the better the repellency. The ideal perfluorocarbon consists of a 5 – 8 fluorocarbon chain terminated with CF₃ groups. The critical surface tension reaches a minimum when the fluorinated carbon number increases to eight⁴⁷. More than this is cost ineffective⁴⁸ because adding fluorine is expensive. It has also been demonstrated that linked carbon atoms that are linear rather than branched give better performance⁴⁰.

Fluorochemical repellents differ from silicone- or hydrocarbon-based repellents in several aspects, of which oil repellency is the most important. Fluorochemicals repel both water and oil⁴⁹, whereas repellents with silicone or hydrocarbons repel only water. Also in respect of hydrophobicity, the oriented perfluoro compounds, as far as the evidence goes, give somewhat higher contact angle than hydrocarbon and silicone groups³⁷ that is attributable to the lower surface energy of the –CF₂- and -CF₃ functionalities⁵¹.

Table 2 Critical surface tension (γ_c) of various functional groups⁴⁷.

Groups	γ_c (mN/m), 20° C
-CF ₃	6
-CF ₂ -	18
-CH ₃	24
Silicone	24
-CH ₂ -	31

2.2.2.2 Silicone

Silicones are inorganic polymers having no carbon as part of the backbone structure. They are polymeric materials in which the basic polymer chain is composed of alternate silicon and oxygen atoms i.e., Si-O-Si linkage⁵². So silicones are better described as polysiloxanes. Certain organic groups can be used to link two or more of these silicon-oxygen backbones and the nature and extent of this cross linking enables a wide variety of products to be

manufactured. By varying the Si-O-Si chain lengths, side groups, and cross linking, silicones can be synthesized into a wide variety of materials. They can vary in consistency from liquid to gel to rubber.

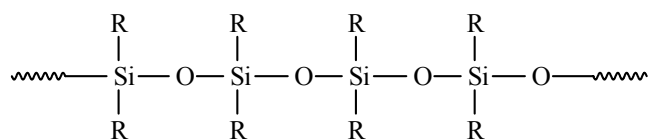

Silicone polymer

The substituent groups R can be the same or different and changes in the nature of R groups result in changes in the properties of the fluid. When all the R groups are methyl or phenyl, the fluid is chemically inert and its adhesion to other materials must be explained in physical terms. When some of the R groups are hydrogens, however, the possibility of chemical reaction with the substrate arises.

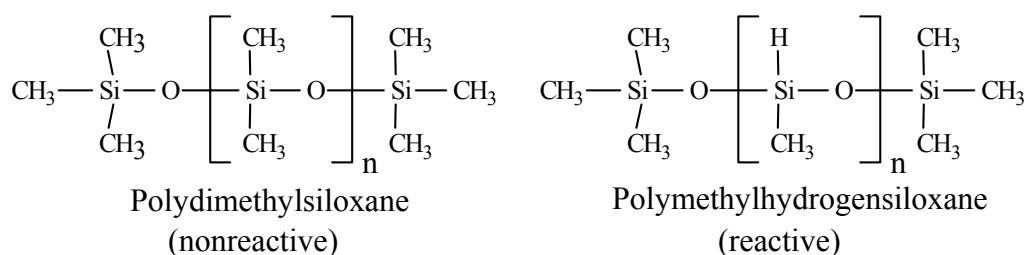

Although several different formulations are commercially available for rendering textiles water-repellent, two fundamentally different types of silicones are exclusively used⁵³:

1. Nonreactive polydimethylsiloxane (PDMS):

This type of product is fully methylated, hence nonreactive up to extremely high temperatures. It has been shown that³⁷, with such polymers, maximum effectiveness in hydrophobization is not achieved without a high curing temperature (2-3 h at 250°C). This elevated temperature can be, however, significantly lowered by introducing titanium or zirconium compounds to silicone.

Two types of this system are commonly used, in solution (e.g., perchloroethylene) and as aqueous emulsion. In the former a readily hydrolysable titanium or zirconium compound and in the aqueous system a water-soluble zirconium salt or titanium compound is utilized as catalyst.

2. Reactive polymethylhydrogensiloxane:

Polymers containing Si – H form the basis of most of the commercially available silicone textile finishes. This product reacts around 150°C with elimination of hydrogen atoms (oxidation) in the presence of organometallic catalysts⁵⁴ e.g., stannous octate, zinc octate, zinc naphthenate) or being aided by moisture present in the curing chamber⁵⁴:

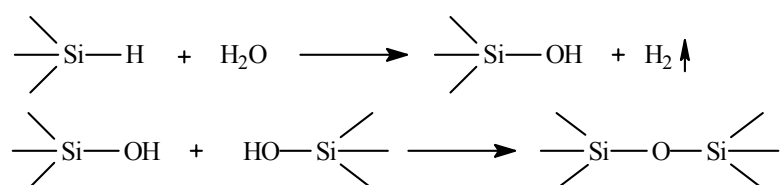

In this manner, a continuous resinous film on the fabric surface is formed enveloping down to the single fiber level that accounts for the hydrophobic effect obtained using this reactive polymer:

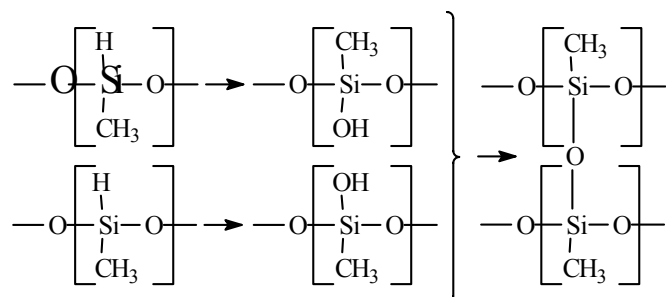

Used alone, this product would impart undesirable hand-feel to textile material; the first product, on the other hand, would result in inadequate fastness to washing and dry cleaning, unless it was exposed to higher temperatures than can be tolerated in textile processing²⁹. In application, the polydimethylsiloxanes are usually mixed with the polyhydrogensiloxanes in order to make a pliable film, the PDMS acts as a plasticizer⁴⁷.

Whatever the mechanism – the fact remains that the siloxane does seem to orient itself on the substrate such that the hydrophobic methyl groups are exposed outward and come into contact with any approaching water droplets. This occurs because of the extreme flexibility of the methylsiloxane chain, the flexibility resulting from the large Si-O-Si bond angle⁵⁵ (and consequent large spacing between methyl groups), and highly ionic character of the siloxane bond. This means that each silicon atom is free to rotate, with its attached groups, 360° about the Si – O bond³⁷. The siloxane chain is thus almost completely sheathed in a field of methyl groups, which sweep out an umbrella-like surface as they rotate with the silicon atom to

which they are attached. Thus the polar groups of fiber being buried so far below the outer surface that they exert little or no attraction on water molecules in contact with the surface. Silicone repellents are more expensive than the wax-salt repellents but less expensive than the fluorochemical finishes⁵⁶. They produce, in general, a very soft, silky grasp, particularly on 100% polyester micro fibers⁵⁷, where they have been found especially useful.

2.2.2 Plasma Modification

The term "plasma" was first used by Irving Langmuir⁵⁸ in 1926 to describe the inner region of an electrical discharge. Later, the definition was broadened to define a state of matter in which a significant number of atom and/or molecules are electrically charged or ionized. The three lower-energy phases of matter are solid, liquid, and gas. Plasma is the fourth state of aggregation^{59,60}. The various states of matter occur as a substance is heated to temperatures above the binding energies for particular states of matter and thereby undergoes phase transitions.

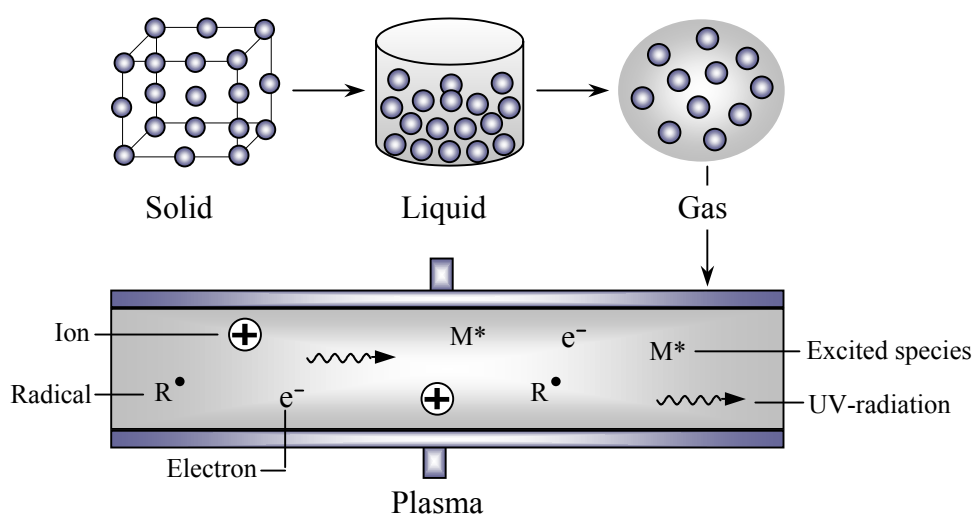

Figure 6 Phase transformation of matter.

Fundamentally, the material is made of atoms, which can be themselves be subdivided into atomic nuclei and electrons. Plasma is the least organized collection of electrons and atomic nuclei, i.e., it is a mixture of these components^{61,62}. Briefly, plasma (also called a partially ionized gas) is an energetic state of matter in which some or all of the electrons in the outer atomic orbital have become separated from the atom. The result is a collection of ions and electrons, which are no longer, bound to each other⁶³⁻⁶⁵. Plasma is by far the most common form of matter, comprising more than 99% of the known visible universe. Commonly

encountered forms of plasma include the sun and other stars (which are plasmas heated by nuclear fusion), lit fluorescent lamps, lightning, and the solar wind.

The gaseous phase is characterized by the formation of atoms, the bonding of atomic nuclei and electrons. A further increase of order by the linking of atoms to form unordered, but dense bonds, allows liquid phase to be created. The highest level of order is, however, in solid bodies such as crystals by the symmetrical organization of atoms. The removal of the atomic bond between electrons and atomic nuclei, typical in plasmas, gives rise to the decisive difference between gases and plasmas. Whereas gases are electrically neutral, plasma can conduct electric currents and can be manipulated by electromagnetic fields. Because this characteristic also occurs if the atomic bond is not completely ionized, and thus, atoms have not given up all electrons, the term partially ionized gas and plasma are used synonymously⁶⁶⁻⁶⁷. Plasma is characterized by the following properties:

- contains an increased number of charge carriers (conductivity)
- quasineutrality (same number of positive and negative charges in a nit volume)
- increased energy and heat content
- creation of equilibrium states

The electrical energy stored in the plasma is converted into the following energy forms:

- kinetic energy of the charged particles (electrons, ions)
- excitation energy of activated particles
- electromagnetic radiation, which is emitted as visible, UV and IR light

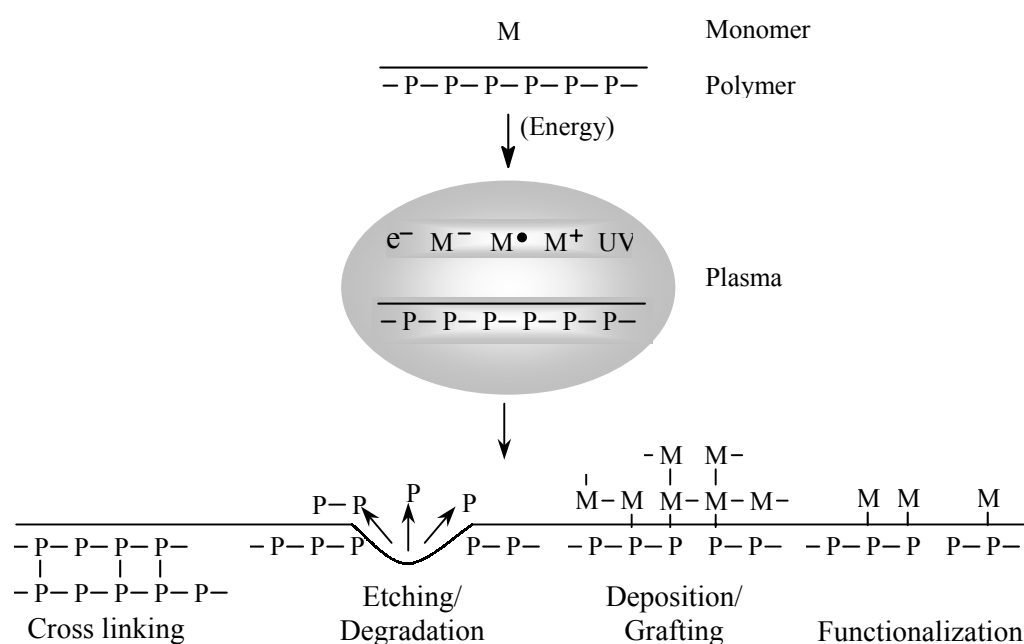

Figure 7 Schematic of the reaction mechanisms of plasma surface modification.

In plasma treatments four major effects on surfaces are normally observed. All are always present to some degree, but one may be favored over the others, depending on the substrate, the gas, the reactor design, and the operating parameters. The four major effects are⁶⁹⁻⁷⁰:

1. Functionalization- incorporation of functional groups onto the surface.
2. Ablation or etching- can remove a weak boundary layer or part of the surface area.
3. Cross linking or branching- can cohesively strengthen the surface layer.
4. Plasma polymerization- deposition of solid polymeric materials onto substrates.

By far the most frequent type of technical production of plasma is the concerted irradiation of electronic fields. Depending upon the frequency used, one decides thereby between alternating current (50 Hz), Audio (kHz)- Radio (MHz) frequency or microwave plasmas (GHz).

2.2.2.1 Low-pressure plasma

There are two broad categories of plasma, high-temperature plasmas and low-temperature or low-pressure plasmas⁷². In the case of thermal plasmas the pressure of the gases is relatively high, which causes full ionization and raises the number of collisions between the particles (neutral, charges, excited, non-excited) and thereby encourages the conveyance of the energy between them. The result is plasma, that finds itself in thermodynamic equilibrium, so that all the approximate particles show the same high energy, which is defined as "hot". The sun is a glowing example of a hot plasma. This type of plasma, because of its high gas temperature, is not suitable for treatment of polymer surface.

On contrary, a low-pressure plasma⁷³⁻⁷⁷ is one where only a small fraction of the atoms in a gas are ionized, and the electrons reach a very high temperature, whereas the ions remain at the ambient temperature. Here, the mean free path is so large, that except through electron collision, no important energy transfer between the particles can take place, so that no thermal equilibrium can emerge and therefore, it is often referred to as "cold plasma"⁷⁸⁻⁷⁹.

Cold plasmas can be used for surface modifications, ranging from the simple topographical changes to the creation of surface functionalities and coatings that are radically different with respect to the bulk material⁸⁰. This type of plasma hardly affects the sample, nevertheless the electrons have energies, which correspond to several 1000 K⁸¹ and can thus provide for chemical and physical reactions, which are otherwise not to be executed at ambient temperature.

The low-pressure plasma is normally generated by an electrical discharge at near ambient temperatures and reduced pressures (10-150 Pa). It is characterized by an electrically

conductive gas of high chemical reactivity, small volume at its working pressure and low tangible heat.

The following elementary processes occur in a low-pressure plasma^{67,68}:

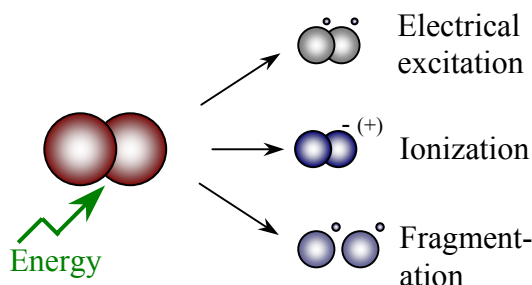
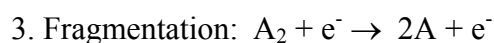
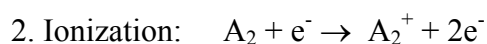

2.2.2.2 Advantages and disadvantages of plasma treatment

Whilst the wet-chemical treatments are becoming increasingly unacceptable because of environmental and safety considerations, modification of polymer surfaces by plasma treatment offers a blend of benefits and overcomes the drawbacks of the classical wet-chemical finishing. The major advantages of plasma surface treatment are⁸²⁻⁸³:

- The lack of harmful by-products from the treatment process, hence environmental friendly. The main by-products are CO, CO₂, and water vapor, none of which are present in toxic quantities.
- Extremely versatile in use, i.e., applicable to all substrates suitable for vacuum processes, i.e., almost free choice of substrate materials.
- The treatment is confined within a few nanometers below the material's surface.
- Low temperature impact on the work piece.
- Optimization of surface properties of materials without alternation of bulk characteristics.
- Elimination of subsequent drying process, since it is a solvent free, dry system.
- Low consumption of chemicals.

Though plasma treatment offers a wide range of advantages over wet-chemical method, however, it also suffers from some drawbacks⁸⁴⁻⁸⁵:

- The main downside of the low-pressure plasma process is the low process pressure required, which takes a great deal of effort to realize from an apparatus standpoint.
- The low process pressure also reduces the activation to the outermost layer of the material surface. Since the polymer chains of the material always exhibit a certain mobility, the activation effect is often diminished after a short time.

- Due to the multitude of elementary reactions it is impossible in most cases to calculate in detail the physical and chemical behavior of a plasma. This applies especially to plasma-surface interactions.
- It is a general problem to restrict the variety of functional groups formed in a plasma treatment to a well-defined set of species.
- Scaling up a plasma process from laboratory size to industrial dimensions is far from a straightforward procedure.
- It is difficult to replace the batch processes by a continuous process (air to air systems).

2.2.2.3 Plasma fluorination

Surface fluorination calls potentially attention for modifying the surface characteristic of a polymer without affecting the bulk properties of polymer materials. For surface fluorination two techniques have been proposed: one is a direct fluorination process with fluorine gas⁸⁶⁻⁸⁸ and the other is a plasma fluorination process⁸⁹⁻⁹². The former process is conventional but suffers from drawbacks: uncontrolled fluorination, degradation of polymer surface, and hazardous fluorine gas⁹³. The plasma fluorination process is preferred rather than the direct

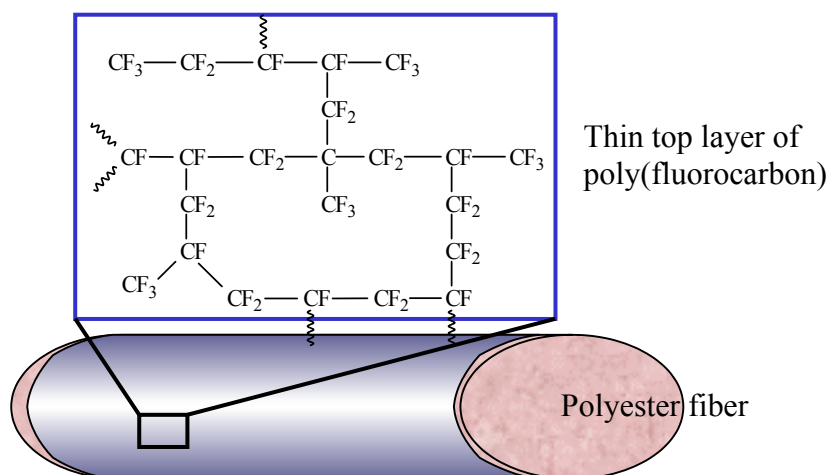

Figure 8 Plasma polymerisation of fluorocarbon by low-pressure plasma treatment.

one with fluorine gas because of easy treatment. The fluorination of polymer surface is accomplished only by exposing them to plasma of fluorine-containing compounds. Plasmas from saturated fluorocarbons, C_nF_{2n+2} ($n = 1, 2, 4$ and 6)⁹⁴ constitute powerful tools for fluorination of polymer surfaces.

Several groups^{95,96} have investigated plasma-fluorination techniques for generating fluorinated surfaces on conventional hydrocarbon polymers. The two principal approaches are

polymerization and plasma grafting⁹¹. For fluorocarbon plasmas, the distinction between polymerization and grafting is not always clear. Coburn and Kay⁹⁷ have shown that for small fluorocarbon molecules the balance between polymerization and grafting or etching can be a strong function of the discharge conditions. This observation could explain the sometimes conflicting reports on fluorocarbon plasmas.

The closer examinations of plasma chemistry revealed that in fluorocarbon discharges, simultaneous etching and polymerization occur⁹⁸. These processes are highly interdependent, and which of these will dominate depends on such factor as the F/C ratio of the monomer gas⁹⁹, reactor pressure, discharge power, flow rate of the precursor gases, location of the substrate with respect to the glow region, reactor geometry, and the mode of coupling the energy with the pressure gas to form the plasma¹⁰⁰. Typically, gases with a high F/C ratio, e.g., CF₄ (F/C = 4), result in efficient etching, whereas a lower F/C ratio gas, e.g., C₂F₄ (F/C = 2), polymerizes easily. Gases with an intermediate F/C ratio¹⁰⁰ such as C₂F₆ (F/C = 3) and C₃F₈ (F/C = 2.67) should give rise to both etching and polymerization. The dissociation of F atoms from lower F/C ratio fluorocarbon based structure requires high energies and consequently C – C scission process, i.e., polymerization is favored¹⁰¹. If the deposition rate is higher than the etching rate, a stable cross linked and uniform over layer will form. Cross linking of polymer chains during fluorination reasonably improves the wash-stability of the modified effects.

The primary step for successful polymerization is the elimination of excess fluorine⁹⁵. This leads to the conclusion that the polymerization is easier if the starting fluorocarbon has fewer

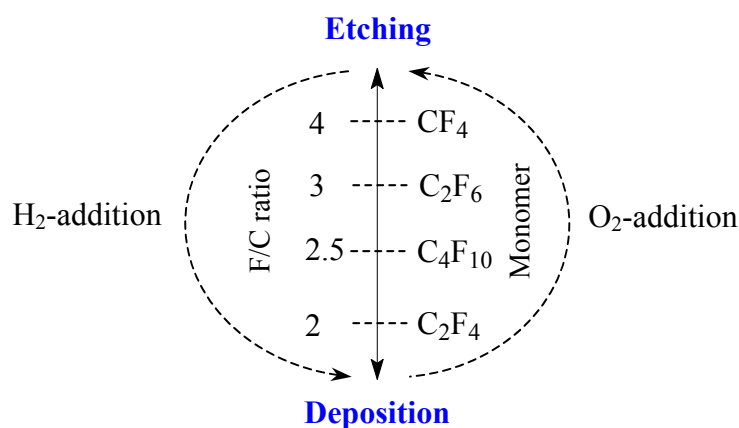

Figure 9 Competition of etching and polymerization process depending on the F/C ratio and addition of hydrogen or oxygen species.

fluorine atoms per carbon atom. In case of higher F/C ratio the deposition rate can be substantially increased by incorporation of a reducing agent such as H₂, CH₄ or C₂H₄ to the fluorocarbon feed. D'Agostino and coworkers¹⁰² studied the effect of the addition of H₂, a scavenger of fluorine atom, to C_nF_{2n+2} discharges, In all cases the fluorine atom concentration

fell to a minimum at a hydrogen percentage varying between 10% and 18% and the CF and CF₂ radical concentrations increased with the percentage of hydrogen. Thus, in general, addition of reducing species to fluorocarbon plasmas leads to significant rise in polymer deposition.

Different molar ratios of reducing agent and fluorocarbon feed results in different extent of surface modification and the consequent increase in deposition is neither linear nor always ascending. It has been found¹⁰³ that the deposition rate reaches a maximum after incorporation of a certain amount of reducing agents to pure fluorocarbon plasmas, which is reduced again upon any further addition of those fractions.

In the fluorination of surfaces, reactions also depend on polymer substrates. Polymers must have some substituents or multiple bonds, which will be replaced by fluorine or fluorocarbon groups. For efficient fluorination, the substituents, most commonly hydrogen, should come off the surface when they are exposed to plasma. Then, or at the same time, fluorine or fluorocarbon groups which are activated by plasma can fill the vacancies⁹⁵.

After fluorination, in case of polyester material, a range of functionality has been reported to be introduced to the fiber surface that are liable to cause hydrophobicity.

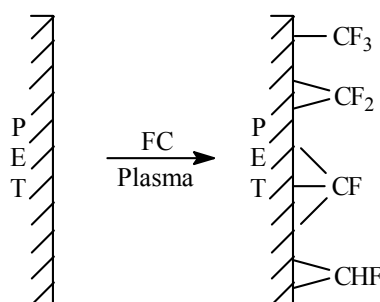

Figure 10 Functional groups introduced to PET surface after fluorocarbon plasma polymerization.

The quantitative implantation of such functional groups largely depends on the monomer used. For example, although both CF₄ and C₂F₆ are good fluorinators, -F and -CF_n are the reactive species in CF₄ plasma because of greater amount of F, while more -CF₃ is found in C₂F₆ plasma because the weaker C - C bond breaks easily. As a result of fluorination on the polymer surface, there are more >CF- groups after CF₄ plasma, and more -CF₃ groups after C₂F₆ plasma⁹⁵. However, this conclusion is not simple and often complicated depending on the several other factors affecting the plasma process.

Extensive works have been conducted for surface fluorination of polymers by using fluoro-containing plasma gases. However, so far the literatures go, plasma treatment has been used not yet to modify the fabric surface for operational purposes.

2.3 Wetting Behavior of Textiles

The wetting of a fiber surface is a function of both the physical and chemical properties of the interface. The main distinction between a surface that is wetted by water, and one that is not wetted, is that a wettable surface allows water to spread over it in a continuous film, whereas on a non-wetted or hydrophobic surface the water stands in separate droplets, covering only a small part of the surface¹⁰⁴.

At the liquid-solid surface interface, if the molecules of the liquid have a stronger attraction to the molecules of the solid surface than to each other (the adhesive forces are stronger than the cohesive forces), then wetting of the surface occurs. Alternately, if the liquid molecules are more strongly attracted to each other and not to the molecules of the solid surface (the cohesive forces are stronger than the adhesive forces), then the liquid beads-up and does not wet the surface of the part.

To measure the wettability and adhesion behavior of textile surfaces against polar liquids a limited variety of methods are available, the followings being well-known in practice:

- Bundesmann rain-shower test.
- Contact angle measurement.
- Sliding angle measurement.

The bundesmann rain-shower test¹⁰⁵ is a visual method and provides only qualitative information of the wettability of the surface. The other two methods present a more reliable basis for the assessment of wetting and adhesion character.

Textile fabrics or even single fibers are nonideal solid surfaces¹⁰⁶. Measuring the wetting of fabric surfaces is a very sophisticated process complicated by surface roughness, heterogeneity, diffusion of liquid into the fiber, and the capillary action of the fiber assembly^{107,108}. Therefore, the experimentally measured (apparent) both contact- and sliding angle for the real fabric-liquid system can differ considerably from the true contact angle, described for an ideal system.

2.3.1 Contact angle

When a liquid is placed in contact with a solid surface, the bare surface of the solid absorbs the vapor of the liquid until the volatility of the absorbed material is equal to that of the liquid. When equilibrium is established, there is a liquid-solid interface between the two phases. The tangent angle between solid and liquid is known as the contact angle usually expressed by θ ¹⁰⁹ (Figure 11). The angle θ is characteristic of the particular liquid/solid interaction; therefore, the contact angle serves as an indication of wettability of the solid by the liquid. The drop of

water forming such an angle may be considered as resting in equilibrium by balancing three forces involved¹¹⁰, namely, the interfacial tension between liquid and vapor γ_{lv} , that between solid and vapor γ_{sv} and that between solid and liquid γ_{sl} , which are correlated by classical Young's equation¹¹¹:

$$\cos \theta = \frac{\gamma_{sv} - \gamma_{sl}}{\gamma_{lv}}$$

where θ is a contact angle of a liquid droplet on a given surface. The difference $\gamma_{sv} - \gamma_{sl}$ has been termed as “wetting tension” or “adhesion tension”¹¹⁷.

If the contact angle θ is zero, the surface is said to be completely wetted. For water-repellency, the contact angle should be higher than 90° . A larger contact angle confers good hydrophobicity on the surface, and the droplets of water tend to run off at a little degree of

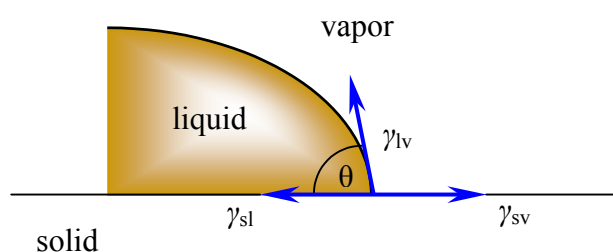

Figure 11 Scheme of three-phase contact.

inclination of the surface. A contact angle of 180° would indicate no adhesion between liquid and solid: since there must always be some adhesion between two phases in contact, the angle never reach 180° , although a water contact angle greater than 170° on nanostructured ACNT (Aligned Carbon Nanotube) film after modification with a fluoroalkylsilane has been reported¹¹².

Surface tension

The thermodynamic definition of wetting is rooted in the concept of surface energy or surface tension. The intermolecular bonds or cohesive forces between the molecules of a liquid cause surface tension. It is a definite and accurately measurable property of the interface between two phases¹¹³.

At the surface of the liquid, the liquid molecules are attracted to each other and exert a net force pulling themselves together. High values of the surface tension means the molecules tend to interact strongly. Lower values mean the molecules do not interact as strongly. Water has a very high value of surface tension because it has a high degree of hydrogen bonding. Organic molecules with polar groups such as iodide and hydroxyl have a slightly lower

surface energy than water. Pure hydrocarbons are even lower, while fluorinated compounds are very low because the fluorine atom won't share electrons very well so only dispersion interactions occur.

Since the surface energy of pure water can be considered constant, the contact angle is determined by the surface energy of the solid surface and that of its interface with water. Lowering the first and increasing the latter increases the contact angle and, therefore, the water-repellency.

There are various theoretical approaches for calculating surface tension of solids:

- Fowkes approach
- Owens-Wendt-Kaelble approach
- Acid-base (van Oss) approach
- Neumann approach

Among these methods, the Owens-Wendt-Kaelble approach¹⁵² is popular and commonly used for determining the solid surface tension. This approach suggests that for polar solids and liquids, both dispersion (d) and hydrogen (h) forces may be important across the interface. Considering a geometric mean relationship, the following equation is recommended for calculation of solid surface tension (γ_s):

$$(1 + \cos \theta) \gamma_l = 2\sqrt{\gamma_s^d \gamma_l^d} + 2\sqrt{\gamma_s^h \gamma_l^h}$$

where γ^h is the component of surface tension caused by both hydrogen and dipole-dipole interactions. A similar equation was approached by Kaelble in terms of dispersion and polar forces, in which γ^h stands for the polar component (γ^p). Solid surface tension components γ_s^d and γ_s^h in the above equation can be obtained by solving two simultaneous equations. For this purpose, two different liquid contact angles on the same solid surface have to be measured.

Critical surface tension

The critical surface tension of a solid, γ_c is defined as the surface tension of a liquid that just completely spreads on a surface. An empirical linear relation has been found between the cosine of the contact angle and the surface tension of the liquid of the sessile drop. The extrapolation of the line to cosine (θ) = 1 gives the "critical surface tension" of the substrate.

All of the polymers in Table 3 are considered to be hydrophobic because their critical surface tensions are well below that of pure water (72 mN/m at 20°C). The critical surface tension is mainly influenced by the outermost layer of atoms at the solid's surface.

Table 3 Critical surface tensions of polymer surfaces⁴⁷.

Solid	γ_c (mN/m)
Poly(tetrafluoroethylene)	18
Poly(dimethyl siloxanes)	23
Poly(ethylene)	31
Poly(ethylene terephthalate)	43
Polyamide 6.6	46

Ultra hydrophobic surface

The surface giving a water contact angle greater than 150° is referred to the ultra or super hydrophobic surface¹¹². Among various factors, surface energy and surface roughness are the dominant factors for the ultra hydrophobicity. As earlier stated, when surface energy is lowered, the hydrophobicity is enhanced. However, a smooth material even with the lowest surface energy (6.7 mN/m for a surface treated with fluorocarbon chemicals) gives a contact angle of only around 120° ³⁵. So, in order to obtain higher contact angle, it is necessary to make smaller contact between droplet and solid surface. This can be ensured by introducing a proper surface roughness.

In fact, surfaces with a water contact angle of more than 150° were developed by introducing proper roughness on materials having low surface energies. A common example of such ultra hydrophobic surface is the so-called lotus effect, is well known for leaves of the lotus flower. High water-repellency of lotus leaves is mainly caused by epicuticular wax crystalloids which cover the cuticular surface in a regular micro relief of about (1 – 5) μm in height⁸.

2.3.2 Sliding angle

Sliding angle or water droplet rolling-off angle is defined as the angle at which water drops on a substrate start rolling down when the substrate is gradually inclined from its initial horizontal level¹¹⁴. It describes the adherence of polar liquid to a surface. A highly hydrophobic surface will expel the water droplets in an instant showing no or minimum adhesion to those.

The contact angle merely reflects the balance of three forces at the point of the water-air-surface interface, whereas the sliding angle reflects the interaction between water and surface in two dimensions⁹⁵. A lower sliding angle represents a little adherence or higher barrier of the surface.

The sliding angle test is performed by using a tilting base¹¹¹. The test starts from a horizontal base (= 0°) and ends with a vertical base (= 90°). The base angle is increased with a certain

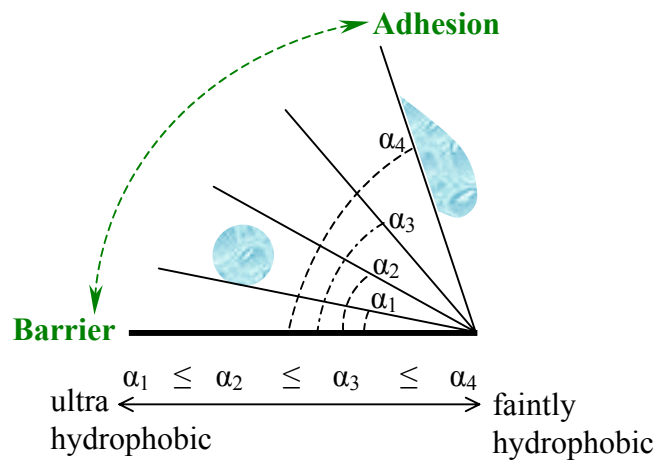

Figure 12 Sliding angles demonstrate the adhesion behavior of hydrophobic surface; sliding angle increases with increasing adhesion.

speed and the point from where the droplets starts moving is registered. From practical viewpoint, this method is significant, since it expresses the angle of expulsion of the water droplets dropped on a given fabric surface, in particular, in case of medical operations, where the relevant person wearing an apron are all along in standing position and in frequent movement.

2.4 OP Textiles

Medical textiles will probably be the field of new millennium. Due to constant improvements and innovations in both medical procedures and textile technology the annual growth of medical textile products during the last two decades occurred at a compound annual rate of 10 – 15 %¹¹⁵.

Textiles in the health service, frequently also designated as medicine or clinical textiles, represent a various and extensive segment within the sphere of technical textiles. Depending on the main fields of application they can be divided into three groups¹³³:

- Medical textiles.
- Hygiene textiles.
- Care textiles.

Medical textiles are used as outer or inner corporal textiles directly for the medical treatment. Hygiene and care textiles serve, however, only for the indirect medical treatment and patient care. They are used approximately 85% for in-patient health care and 15% in the operating room as well as in special areas like the intensive care unit^{133,134}. In the context of this work, the investigations of barrier systems are to be assigned to the latter group.

2.4.1 Overview

In today's operating room, the risk of transmitting infectious disease is a vital concern. The use of surgical gowns has evolved as a standard of practice¹¹⁶. Their primary purpose is to protect sterile surgical zones from microbial invasion. Loosely woven cotton fabric had been used universally as bacteriological barrier since the turn of the century. It was not until 1939 that the fabric's effectiveness was first questioned. As a result of blood and saline being able to penetrate the gowns easily to the skin of the person involved, clinicians claimed for a secured means that is impermeable to body fluids.

After a decade of trial and error, a plastic surgical material was developed that made an ideal bacteriological barrier¹¹⁷, but it was deemed unsuitable because it retained heat and thus elevated the patient's temperature. Then the industry responded by introducing a variety of laminated materials made of combination of polyethylene film and the nonwoven, single-use fabric¹¹⁸. At the beginning of the seventies surgical gown made of better quality cotton cotton-polyester mixtures were introduced in the operating room. Without additional finishing they were permeable for all bacteria and viruses as well as for contaminated body fluids due to a pore size of at least 80 μm ¹¹⁹ and lost slowly the appeal to the surgeons as suitable barrier materials.

The unsatisfactory fulfillment of the hygienic requirements “barrier to particle loaded liquids” led first to an addition or a change of classical OR textiles by so-called barrier articles in the form of tightly woven fabrics with hydrophobic surface modification.

There are two types of surgical gowns on the market today - disposable and reusable. Disposable gowns are designed for single use and are made of a nonwoven fabric. Reusable gowns are made of woven fabrics and require laundering and sterilization between uses. Approximately 20% of the gowns used today are reusable¹²⁰. The ability of reusable gowns to prevent transfer of pathogens through body fluids is determined by fabric characteristics, the bacteria, and the characteristics of the bacteria-containing fluid.

During the last few years, the use of micro fibers in reusable OP materials have drawn much attention of the critical surgical fields due to their capability of preventing massive leaks from liquids. In addition to fuller handle, excellent drapability and comfort, the tightly woven fabrics made of polyester micro fibers give good water proofing and wind resistant effects, much better than those obtained with coated or laminated or finished conventional fabrics. These tightly woven and finished fabrics impede water droplets from penetrating ensuring an initial barrier effect but allow water vapors to permeate, resulting in increased comfort, especially for the long surgical procedures.

2.4.2 Barrier effect

By the term "barrier fabric" a textile planar formation is to be understood, which exercises certain protective functions such as thermal protection, waterproof, impermeability for liquids, bacteria, virus, solid particles etc. Bacteria and virus are to be found in nature frequently. Humans protect themselves with their immune system from an excessive microbe infestation. Barrier fabrics provide protection against microorganisms that is done either by the fabric itself or by depositing an additive on the material¹²¹.

In order to ensure a sufficient security in the practical application, two different basic requirements must be fulfilled:

1. Barrier to liquids.
2. Barrier to suspended particles.

Bacteria and other pathogens are transported from one location to another by carriers (e.g., dust, liquid). Body fluid, in particular, blood is considered to be the most common pathway in the OR. Therefore, the fabric used in surgical gowns must prevent the transmission of both the above parameters to be effective in protecting scrub personnel and patients from exposure to pathogens in the surgical environment. Many studies have been conducted to evaluate the

effectiveness of various surgical gowns as barriers to microbial transfer. The following two parameters have been identified as critical characteristics:

1. Fabric construction (physical barrier).
2. Hydrophobicity (chemical barrier).

The physical barrier, in essence, relates to the geometry of construction of the fabric materials. There are plenty of different fabric constructions available on the market. The barrier function of such fabrics depends on the surface structure, and also on the number and size of the continuous pores running through the fabric – the pores which run both between the filaments in the filament yarn and also between the filament yarns¹²².

Pore size and its form are determined by the thread and fabric construction parameters. They should be as small as possible, which will not allow the penetration of the particles into the fabric. The pore size is reduced to a minimum by using micro fibers. The fine counts of the micro fibers make it possible to manufacture very densely composed fabrics.

Microorganisms like bacteria are one-celled living organisms. They vary in size as much as in shape. The average bacterium is 0.2 to about 6 μm ¹²³ over a single dimension. The viruses are, on the other hand, more tiny geometric structures ranging in size from 0.01 – 0.3 μm ¹²⁴.

The dimensions of microorganisms suggest that production of tightly woven fabrics with pore diameter under 0.2 μm would be preventive from penetration of almost all bacteria, though most of the viruses will go through. As earlier stated, by traditional cotton fabrics a pore size of 80 μm is given and they are, therefore, entirely unsuitable for particle hindrance. By using micro fiber or fleece material the pore dimension could be reduced to approx. 5 – 8 μm ¹²⁴ but no causative organism would be held off. Exclusively, adding a layer of impermeable film to the fabric base, a pore size of 0.02 μm ¹²⁵ is to be reached that will safeguard the transmission of carriers; however, the comfort characteristics of the gown may be substantially reduced.

The above discussion reveals that textile materials endowed with larger pore structure are apparently inefficient in barrier effects considering that the pathogens are predominantly adhered to solid particles or liquids¹²⁶. In addition to compact fabric geometry, it is, therefore, necessary to introduce a chemical barrier in form of hydrophobic modification of the surface to strengthen the barrier functions of the fabric. Because of lower surface energy of the modified fabric the adhesion of the particle loaded liquids on the surface will be prevented and thus, a pre-barrier effect will be ensured with minimum reduction in breathability.

Since neither the fabric construction nor the hydrophobic modification are alone effective in providing a sufficient barrier property, the venture of combining these two parameters shows an optimistic way to reach a guaranteed barrier materials for operation theater.

2.4.3 General requirements

As claimed first and foremost by the medical occupational persons, surgical apparel worn during surgical procedures must protect against exposure to pathogens through body fluids¹²⁰. It is often not be previously known what pathogens a surgical patient's body fluids may harbor; therefore, the health care workers must have a high level of assurance that the apparel worn during a surgical procedure will protect scrub personnel from exposure.

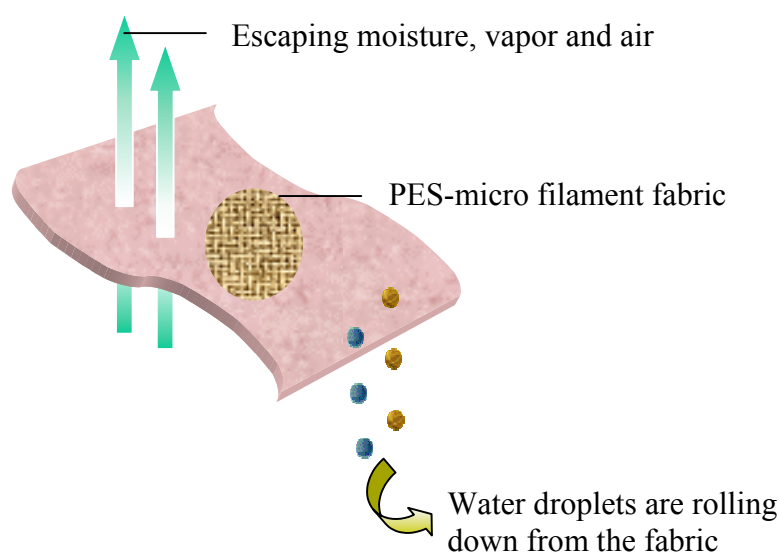

Figure 13 Model of a hydrophobic modified barrier fabric.

Apart from the barrier effect, the general requirements imposed on surgical fabrics include a wide range of properties which in recent decades have become specified both more often and more closely, especially those concerning hygienic and physiological properties¹²⁷.

In excess of safety standards and general hygienic characteristics, some other specific quality requirements are to be maintained. One of the most serious limitations of existing barrier fabrics is that they lack acceptable comfort properties¹²⁸, sometimes being completely impervious to moisture vapor transport. Hence the user is easily overheated. The barrier fabric should be however, like a "second skin" to the human body¹²⁹ i.e., the transport of warmth and humidity through the porosity of the fabric should be optimum.

Beside the wearing comfort, several other characteristics also deserve similar importance. The original textile-physical properties, like soft handle, tensile strength, drape etc. should not be severely affected due to the surface modification.

Prior to repeated use, the surgical gowns are required to be washed. The extent of reusability of a particular gown is mainly determined by the longevity of the given finishing effects. The longer life cycle of such materials would be very cost effective. Hence, in addition to the

properties mentioned above, a certain degree of permanence to washing, sterilization and dry-cleaning¹³⁰ of the hydrophobic treatment effect is also of high demand.

3. OBJECTIVE

As the title implies the chief goal of the present work is the improvement of the barrier effects of textile fabrics in the medical sector, in particular, in the operating room, which would be an effective safeguard against the causative pathogens allowing the health workers to work in and around hostile atmospheres and to accomplish useful tasks. While the classical textile materials are used for clothing purposes, the concern of this work is not the routine needs; the main focus is on more sophisticated needs, protection in clinical environments where infectious hazards and risks are present that have the potential to be health threatening to the person particularly involved in surgical procedures.

A surgical gown using polyester micro filament fabric would have to be designed to be a novel barrier material featured with new required aesthetic properties, which might be an authentic barrier between the infection source (micro organisms like bacteria and viruses of different size and geometry) and the healthy person and thus, reducing the risk of cross-infections. The acquisition of such functional barrier effects in addition to micro and compact structure of polyester fabric are to be realized by surface hydrophobization using two different methods:

- Wet-finishing using fluorocarbon and silicone products.
- Modification by low-pressure fluoro-containing plasma treatment.

The basic principle of such hydrophobic modifications is to create a so-called ultra hydrophobic surface or at least close to it. The newly designed surface, because of its highly inert character, will impose a pre-barrier towards the liquids containing hostile elements, which will, in principle, not be allowed to adhere to the bulk material. Thus, due to lack of adhesion force between two phases (solid and liquid) the detachment of bacterial and viral agents from the surface will be automatically ensured without other intervention.

Wet-finishing using fluorocarbon and silicone products is a classical route to render the fabric surface hydrophobic. The hydrophobicity given by a particular product largely depends on its basic chemical constitution. Regardless of the origin and the chemical composition, each commercial derivative invariably requires favorable applying conditions for its maximum effectiveness. Therefore, the optimization of the application parameters of the selected

chemicals such as pick-up%, pH of the finishing liquor, time and temperature for drying and condensation etc. is a great deal of the present work.

On the other hand, low-pressure plasma treatment using fluoro-containing gas is a new and elegant method of surface modification. As plasma gas, saturated fluorocarbon such as CF_4 and C_2F_6 and their mixtures with reducing agent will be used in this work. Evidence available shows that these plasmas have been increasingly used in the last decade for surface modification of polymeric materials. However, their use in textile sector, particularly to enhance the barrier effect of operation fabrics is totally a novel approach. Due to newness of this technique, extensive investigations have been designed to carry out on it, which mainly include variation in treatment time, rate of gas flow, feed composition and mode of treatment. In doing so, the retaining of other key parameters like permeability to air, pleasant grasp and tensile strength is of synchronistic demand. These inherent textile physical characteristics should be kept largely unaltered by the modification process. Of further significance is the reusability of the material, i.e., the durability of the treatment effects on washing which is, therefore, also a matter of high anticipation.

The radical concern of the work comprises the characterization of the modified surface from a viewpoint of hydrophobicity and chemical analysis. After modification the polymer surface is, in essence, newly designed, hence it is necessary to gain insight into the modified surface through wettability measurements, and chemical analysis. The degree of hydrophobicity will be quantified by means of contact angle and sliding angle measurements, where the latter technique will provide, in addition, information of the adhesion properties of the surfaces. The qualitative as well as the quantitative information of the foreign entities introduced to the material surface after modification process will be analyzed by X-ray photoelectron microscopy (XPS). Thus, the measurements of the hydrophobic character and the identification as well as the quantification of the developed functionalities on the surface as a result of a particular treatment will create a platform for designing the further modification steps.

Whatever the technique used, in excess of incorporation of functional groups on to the surface, the modification is often accompanied by certain physical changes. The dimension of changes is diverse that may range from nanoscale to micrometer level. After modification, previously homogeneous polymer surface gets often roughened due to particles deposition or etching process, which exercise significant influences on the wetting behavior as well as on the bulk properties of the material. It is, thus, necessary to conduct topographical investigations after modificatory treatments that are well documented by means of electron microscopy, e.g., REM.

Last but of capital importance is the evaluation of the barrier properties of the fabric that brings out, in fact, the ultimate objective of the work. Hence, it is essentially required to

determine the ability of the fabric to impose barrier against absorption of the real careers such as body fluids. The absorption behavior is to be analyzed in fuller details using primarily a synthetic blood (a man-model of blood), then protein solution (only a fraction of blood), and finally human blood to gain an actual reflection of the barrier characteristics of the modified surfaces. Deviating from the conventional procedures for the evaluation of the barrier effects, all the experiments will be accomplished utilizing specially designed methods that are believed to be more reliable and close to the practical demonstrations encountered during surgical activities.

The quantitative information of the absorption tests, i.e., the penetration of the test fluids through the fabric materials will be determined as a measure of absorbed dyestuffs by means of a colorimeter. The extent of absorption or expulsion of the liquids by the bulk fabric will be a perspicuous indicative of the efficiency of the attained barrier properties.

This work is part of a large cooperation where the other project will focus on fabric design and structure evaluation. The final goal of the total project is to improve both fabric structure and surface barrier. In the context of this part a chemical barrier will be introduced first to a commercial polyester micro filament fabric surface by hydrophobization using different methods. The optimized results obtained thereby will be finally applied to the ideal fabric developed by the partner project.

4. RESULTS AND DISCUSSION

A commercial polyester micro filament fabric has been used to carry out the wet-finishing treatments. The received fabric was unfinished and contained sizing materials applied at the yarn stage. To avoid any detrimental effect on the performance of the modification caused by the sizing agents, they were completely removed from the fabric prior to treatments by a desizing operation. The details of the fabric and the desizing procedure have been described in the experimental part of this work.

4.1 Wet -Finishing

4.1.1 Selection of appropriate hydrophobic agents

In the development of durable and permeable water-repellents, the possibility of applying hydrophobic material on micro fibers¹³⁵ to ensure outstanding resistance to washing, dry-cleaning, weathering, all the various agencies to which the fabric may be subjected, has already drawn much attention. Systems based on silicone or fluorocarbon polymers to execute hydrophobic behavior on the textile fibers are very versatile in application^{136,137}. Depending on the type of polymer and basic constituents, various degrees of water-repellency can be achieved.

As described in the theoretical part, in addition to structural design an ultra hydrophobically modified fabric will impose a surface barrier towards particle-loaded polar liquids due to its chemical inertness. To reach this goal, different commercial fluorocarbon chemicals and silicone products were applied on the pre-treated PES micro filament fabric in different quantities using a standard procedure. The applied fluorochemicals varied in respect of the basis polymer (acrylate or urethane), the fluorine content and the copolymerization. The used silicone products were polydimethylsiloxane and polymethylhydrogensiloxane as described in Table 4.

It was observed that the performance of an individual chemical was highly dependent on its applied concentration. In general, all the chemicals applied have been found to confer comparable hydrophobicity to the fabric surface. At the same time, the deterioration of bulk characteristics of the material such as hand-feel and permeation to air with exception (e.g., polyurethane-based fluorocarbon finishing) was of little account.

Table 4 lists the best results in terms of wetting behavior as well as the minimum change in the air permeability of the fabric. It is apparent that the fluorocarbon-treated surfaces exhibited, in general, a better water-repellence, with D-86071 reaching the highest contact angle, which is to be explained with the higher fluorine content of this chemical. The modification by D-97105 also led to attain a comparable contact angle that was close to the value obtained by D-86071.

The results plotted in Table 4 show further that the silicone compounds conferred somewhat lower contact angle than the fluorocarbon derivatives, values attained varied from 134 to 137°. The methyl groups have a reasonably higher surface tension (24 mN/m)^{31,41} compared to that of the perfluoroalkyl moieties¹³⁸. Evidences available show further that the attractive field of force around CH₃ is higher than those of CF₃ and CF₂ groups³⁷. Since the siloxanes do seem to orient themselves on the substrate such that the hydrophobic methyl groups are exposed, a relative higher surface tension is consequently given on a silicone-treated surface resulting in a bit lower degree of hydrophobicity.

Table 4 Comparison of the finishing effects (without wetting agent, pick-up = 60%, drying = 100°C/90s, condensation = 180°C/60s).

Finishing agents	Chemical constitution	Contact angle (°)	Decrease in air permeability (%)
D-480 (30 g/l)	Fluorinated acrylate + VdC, lower fluorine content	138.0 ± 0.9	14
D-86074 (30 g/l)	Fluorinated acrylate, medium fluorine content	140.3 ± 1.6	19
D-86071 (30 g/l)	Fluorinated acrylate + VdC, higher fluorine content	143.4 ± 1.4	15
D-97105 (30 g/l)	Pure acrylate based-FC	141.4 ± 1.3	24
D-470 (30 g/l)	Pure acrylate based-FC	138.6 ± 1.9	18
R-C 97660 (50 g/l)	Fluorinated urethane	142.4 ± 1.8	37
P-40159 (40 g/l)	Polydimethylsiloxane	134.2 ± 1.3	15
P-SISW (20 g/l)	Polymethylhydrogensiloxane	137.5 ± 1.8	17

(VdC = Vinylidene chloride; FC = Fluorocarbon)

To realize an ideal hydrophobic surface for OP textiles the utmost retention of the air permeability of the bulk fabric is also claimed in the same breath. Indeed, both fluorocarbons and silicones are not waterproofers but rather they are water-repellents. That is to say, these compounds do not, in general, form an impervious film over the surface treated¹³⁹. As

presented in Table 4, compared to all other fluorocarbon species, the treatment with D-86071 seemed to be better and promising in this regard, whereas the major drawback particularly of the urethane based fluorocarbon product, R-C 97660 was the substantial reduction in the air permeability. It reveals that the filaments of the fabrics got sticky due to the treatment with this finishing agent (R-C 97660). So far better results were obtained by silicone treatments, the air permeability was maintained more or less same as achieved by fluorinated acrylate polymer.

Comonomers are added to principal monomer to give the final polymer some desirable properties. Discussing the surface hydrophobicity by applying fluorocarbon compounds, the contribution of vinylidene chloride ($\text{CH}_2=\text{CCl}_2$) as a comonomer to the finishing property also deserves consideration. In our studies, its presence caused invariably a minimum reduction of air permeability of the fabric in comparison to those attained by the chemicals without copolymerization (Table 4).

Selection of best-suited chemicals

The principal aim of using various finishes on fibrous materials is the same: increase of water contact angle as high as possible. As already discussed, if the basic requirements for surgical textiles are taken into account, beside making the fabric impervious to liquid water, several other characteristics are also crucial, like keeping the permeability to air and water vapor to a maximum. Therefore, strong emphasis was given to combine these two particular properties in ascertaining the appropriate finishing chemicals to meet the general demands of an OP-textile. In this connection, the handle of the finished fabric being a secondary parameter was also considered to assess the performance.

A particular finishing agent satisfying all these three parameters was difficult to found. Some of them, polyurethane based fluorocarbon being a glowing example (Table 4), ensured comparable water-repellency, a soft-feel of the fabric was also given but the decrease in air permeability was too severe (37%) to choose it as an optimal finishing agent. In an ideal case such as by finishing with D-86071, the hydrophobic substance is supposed to be deposited on the fabric surface in such a fashion that a continuous film was not formed resulting in lower decrease in air permeability (only 15%).

In practice, the cost of production plays a vital role in choosing a particular chemical for any kind of finish. Taking this into consideration, the choice was also driven by the need for an inexpensive chemical providing higher contact angle at lower concentration.

In general conspectus, fluorochemicals seemed to be superior to silicone products in respect of contact angle values, even though the pleasant handle of the fabric obtained from all sorts

of silicone chemicals allowed them to be competent candidates for the next investigations. Silicones usually impart a whole range of softening and unique tactile properties to the fabric¹⁴⁰, whilst that was almost unachievable in case of the used fluorocarbon derivatives because of the inherently hard nature of the acrylate portion of a fluorocarbon compound liable to cause adhesion to the fiber¹³⁹.

After a statistically oriented experimental procedure using all the given chemicals and systematic evaluation of the acquired results, the following three chemicals were chosen for further optimization of their performance:

1. Fluorocarbon:
 - a) D – 86071
 - b) D – 97105
2. Silicone:
 - a) P – SISW

4.1.2 Optimization of the application conditions

To reach an optimal level of finishing effect of the applied chemicals and for the formation of their necessary surface arrangements the parameters of the application process must be adapted to those of the textile fibers.

Table 5 Parameters exercising insignificant influence on wetting behavior and air permeability.

Parameter		Contact angle (°)			Decrease in air permeability (%)		
		<i>D-86071</i>	<i>D-97105</i>	<i>P-SISW</i>	<i>D-86071</i>	<i>D-97105</i>	<i>P-SISW</i>
Variation of pH	CH ₃ COOH= 0 g/l	145.8	143.4	139.8	14	17	17
	CH ₃ COOH= 1 g/l	145.0	144.1	138.7			
	CH ₃ COOH= 3 g/l	144.5	144.7	137.9			
Drying temp. (°C); time = 90s	80	145.1	143.3	139.5	14	16	15
	100	145.8	143.5	140.6			
	120	145.1	144.0	139.4			
Drying time (s); temp. = 100°C	120	144.8	144.6	138.2	13	16	15
	240	145.5	144.0	138.7			
	360	145.4	143.0	139.9			
Fixation time (s); temp. = 160°C	120	146.9	145.1	141.0	10	14	13
	240	147.1	145.8	140.5			
	360	145.4	144.5	140.0			

Fluorocarbon and silicone products are self-curing systems and need optimal treatment conditions to get the desired finishing effect. Sufficient effects are only received if optimal cross linking conditions are present¹⁴¹. By the variation of the technological parameters it is also possible to achieve a given distribution of the pore size depending on the penetrating depth of the finishing agents.

The execution of the treatment procedure of the PES-fabric by given chemicals was carried out according to a statistical plan, where the following parameters were varied to optimize the application conditions:

- pH value
- pick-up%
- drying temperature and time
- fixing temperature and time

Thereby a dependence of the wetting behavior and the air permeability on the pick-up% and the fixing temperature was determined. The other parameters did not exerted significant influence within the examined range (Table 5).

It has been observed that with increase of the pick-up% both the contact angle and the air permeability increase (Figure 14). The increased hydrophobicity is to be explained with a rising concentration of the fluorocarbon groups at the fiber surface. The air permeability decreasing with declining pick-up% can be interpreted with the fact that a lower pick-up% was a consequence of the higher pressure of the padding mangle, which led to an intensified penetration of the liquor into the fiber cavities and possibly a compression of the fabric structure.

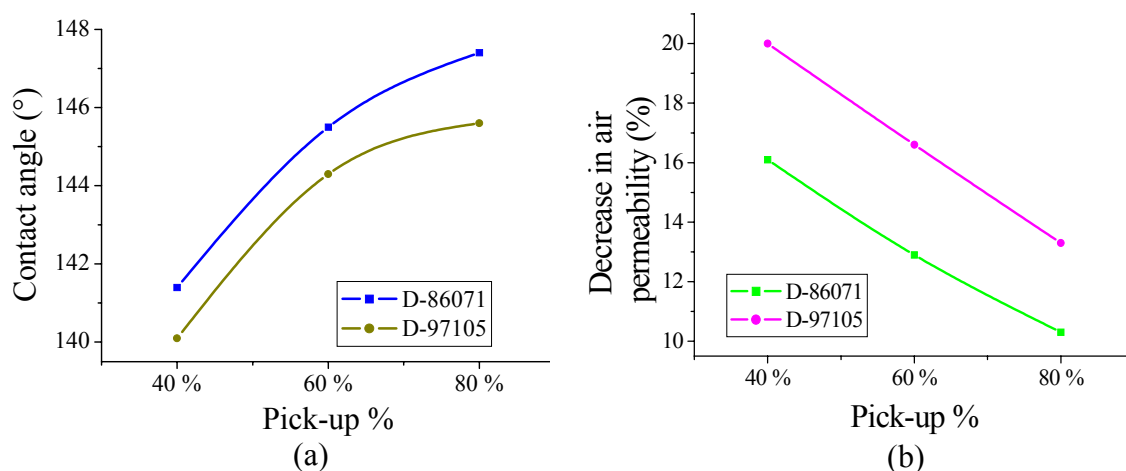

Figure 14 Influence of pick-up % of finishing liquor on contact angle (a) and on decrease in air permeability (b).

Figure 15 illustrates the effect of varying the curing time and temperature showing that better results can be obtained with comparative longer curing at 160°C. It has been found that an increase in fixation temperature with simultaneous decrease in fixation time resulted in a reduction in contact angles as well as in air permeability of the fabric, which indicates that at higher temperatures of treatment the structure of the polymer film on the fiber and its degree of activity are negatively affected.

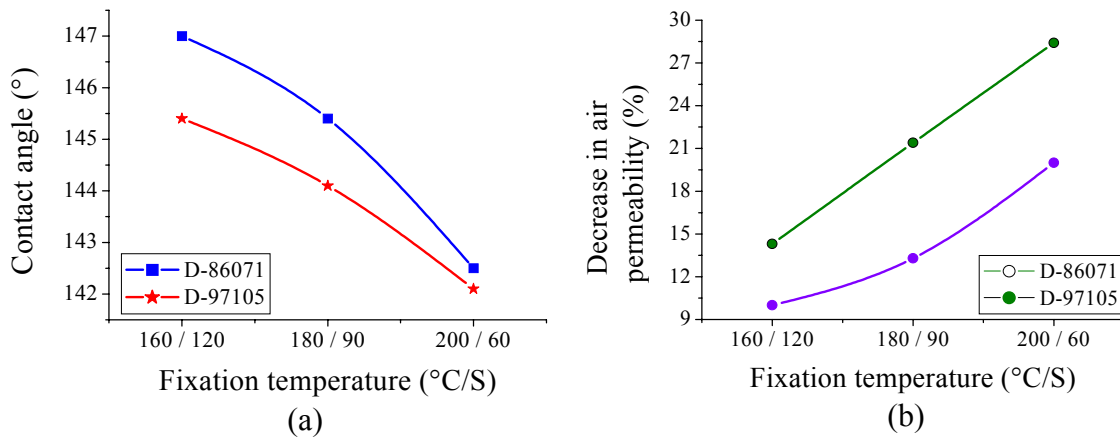

Figure 15 Changes in contact angle (a) and in decrease in air permeability (b) with variation in fixation temperatures.

Low temperatures are generally favorable, because the yellowing tendency of the white fabric is reduced thereby¹⁴². In addition, curing at elevated temperatures is expected to have undesirable effects on textile fibers, dyestuffs and resins³⁷. It is noteworthy that alike fluorocarbon chemicals the silicone-based products have also shown almost similar behavior by variation of pick-up% and temperature of fixation.

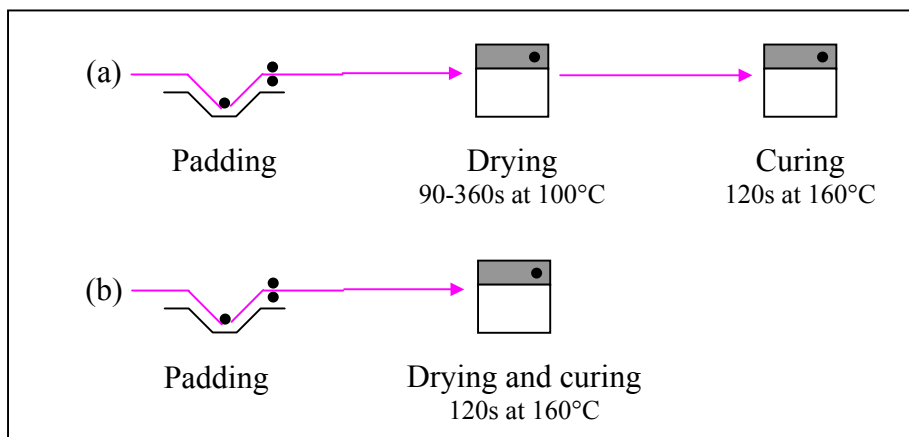

Figure 16 Curing of the padded fabric with (a) and without (b) pre-drying.

As a comparative study, the curing of the padded material with given chemicals was accomplished with or without pre-drying as outlined in Figure 16. No better or inferior results were reported if the pre-drying process is omitted. Despite of the same level of water-repellency achievable by a rapid curing method (without pre-drying) offering at the same time reduced cost of production, a direct curing of the substrate is not suggested. Such an endeavor may lead to trapping of the tiny water bubble within the intermolecular spaces of the fiber, which may in turn cause shrinkage of the fiber and imperfect cross linking of the polymer film.

Optimized application parameters

After a series of experiments and evaluation of the resulted values the following application formulations were found to confer the best finishing effects in terms of wetting behavior and permeability to air of the treated fabrics:

pH-value :	D-86071 :	3.7 – 4.0 (CH ₃ COOH = 1 g/l)
	D-97105 :	3.3 – 3.6 (CH ₃ COOH = 1 g/l)
	P – SISW:	4.5 – 4.8 (CH ₃ COOH = 1 g/l)
Pick-up		80 %
Drying temperature and time		100°C / 90s
Curing temperature and time		160°C / 120s

Since different pH-values, variation in drying and curing time did not have any significant influence on the results, moderate concentration of acetic acid and lowest drying and curing temperatures have been selected to avoid unnecessary processing costs. According to product information and procedure suggested by the chemicals supplier¹⁴³, an acidic bath is favorable for the given finishing agents. Therefore, at least a minimum concentration of acidic acid (1 g/l) was used in all cases to be on the safe side, although the same results were obtained without adding any acetic acid, which was probably caused by the acidic nature of the supplied water.

4.1.3 Influencing factors other than the application parameters

Apart from the stated application parameters a number of other physical and chemical factors have been found to exert significant influence on the extent of modification of the material. These are discussed below in fuller details.

4.1.3.1 *Wetting agent*

The wetting of the fiber material belongs to the elementary requirements and is considered to be a strong prerequisite for every wet-processing¹⁴⁴. Fabric and yarn construction as well as fiber morphology affect the rate of wetting more than does the chemical nature of the fiber material. Synthetic fibers are smooth. Micro fibers are certainly much better aligned and have uniform diameters. This results in good wetting¹⁴⁵, but not high enough for a prompt and maximum penetration of the padding liquor. The role of the wetting agent is, therefore, the subject of much discussion because of its well-known ability in lowering the surface tension allowing an instant and thorough wetting of the material.

If a drop of liquid is brought into contact with a fiber surface, the wetting phenomenon depends on the magnitude of different surface tensions available³¹. The use of a wetting agent,

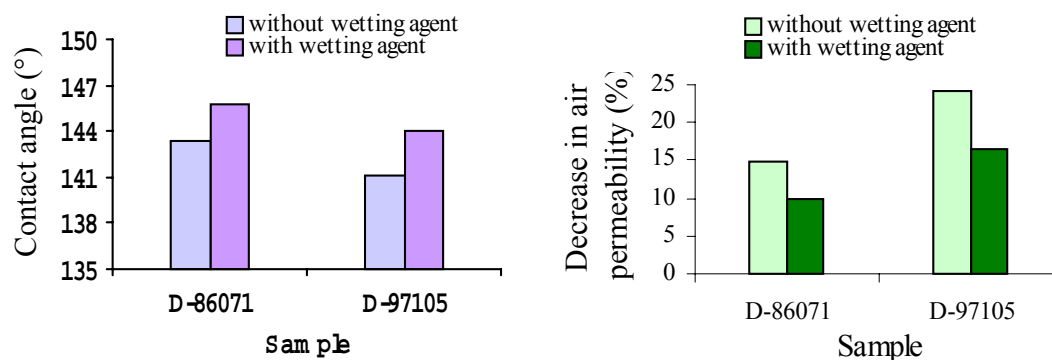

Figure 17 Effect of wetting agent (3 g/l).

which represents detergent in respect of their chemical structure¹⁴⁶, evidently reduces both the surface tension of the liquid and its interfacial tension against the solid¹⁴⁷ conferring improved wetting properties to the material.

In our works, a non-ionic wetting agent, R- 495 (phosphoric acid ester)¹⁴³ was used to carry out the experiments. Figure 17 shows the optimal results attained by two different fluorocarbon-finishing products under the application of the wetting agent. Both the contact angle and the air permeability were found to increase by using the wetting agent. As already stated, the reason for this effect was the reduction of the surface tension by the wetting agent, which caused a rapid wetting of the fiber through the finishing liquor (displacement of air) as well as a better penetration of the chemicals into the fiber cavities. Furthermore, the influence of using the wetting agent is also accompanied by a more even distribution of the finishing agent¹⁴⁸ on the fiber surface. An unequal spreading of the chemicals is, however, fully undesirable that may result in uneven hydrophobicity.

Extra care was taken in applying the quantity of the wetting agent, since it was observed that the positive trend (Figure 17) was more than cancelled out by its excess presence in the

aqueous solution. The amount of wetting agent showed no adverse effect on the behavior of the fabric as long as a minimum of about 3% was incorporated into the treating bath. Its use in excess of 3 g/l caused undesirable decrease both in the contact angle as well as in the air

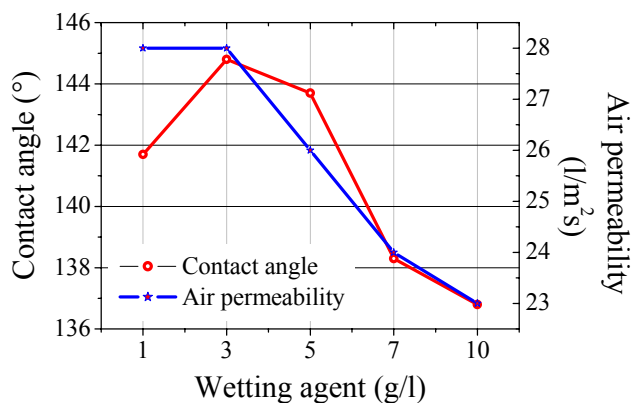

Figure 18 Variation in contact angle and air permeability as a function of wetting agent concentration (fluorocarbon, D – 97105 = 30 g/l).

permeability of the fabric (Figure 18). These impairments in expected properties are to be explained by the deposition of some wetting agents on the surface caused by overdosing¹⁴⁹. The excess amount of wetting agent may result one hand, in increased surface tension and on the other hand, may also cover some of the fiber cavities.

4.1.3.2 Fluorine content

Fluorochemical repellents are unique in that they confer both oil and water-repellency to fabrics. This ability of fluorochemicals is related to their low surface energy, which depends on the structure of the fluorocarbon segment, the non-fluorinated segment of the molecule, the orientation of the fluorocarbon tail, the distribution and above all, the amount of their fluorine content.

The fluorochemical repellents available on the market are based to a large extent on vinyl or acrylate polymers³¹. The perfluoro segment is there as a side chain grafted to the polymer backbone. Being nonpolar, it wants to orient away from polar forces, thus forcing itself away from the fabric surface toward the air interface and giving a reasonably close packed surface comprising of – CF₂ – and – CF₃ groups, which are, in fact, decisive for the repellence effect. Hence the amount of the fluorine content in the chemicals is needed to predetermine to get a desired level of water-repellency.

To carry out the investigations, 3 different fluorocarbon-finishing agents were applied. The exact composition was not given, however, they exhibited differences in respect of their

fluorine content: low (D-480), medium (D-86074), high (D-86071)¹⁴³. As it is figuratively illustrated in Figure 19, the contact angle of the treated fabric surface was observed to increase with increasing fluorine content of the applied chemicals. These results are well in accord with the expectation since the surface energy of a polymer is directly related to the functional groups present at the surface¹⁵⁰: higher amount of fluorocarbon moieties leading to a more inert surface.

It is not only the concentration of fluorine but also the position at which it is incorporated in the polymer chain is important when considering the environmental stability of the finishing

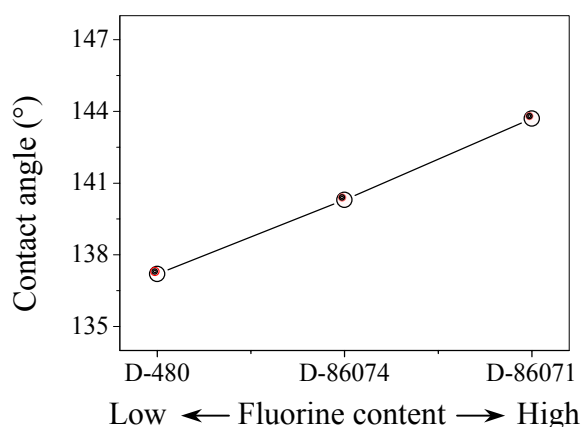

Figure 19 Contact angle improved by increased fluorine content of the fluorocarbon chemicals (concentration of each fluorocarbon, 30 g/l).

effects. All the fluorocarbon chemicals used in the context of this work were found not to be susceptible to any outdoor exposure. After a 6 months-long storage period in normal atmospheric conditions no deterioration of the attained hydrophobic effect has been taken place.

4.1.3.3 Regenerating treatment after washing

For an optimal effect of the fluorocarbon chemicals not only the chemical structure of the products that is decisive, but also the organization and orientation of the fluorinated segments are of great concern⁴¹. How and under which conditions a fluorochemical is applied, dried and cooled down, results in a specific surface structure endowed with different chemical arrangements and consequently distinct surface energies and wetting behavior.

In order to examine this change in more detail, the micro filament polyester fabric was washed, dried at room temperature and heat treated for 15 min at various temperatures. During washing treatment, the hydrophilic part of the fluorocarbon segments (made up of an

ester group) ensures the wetting of the fabric. As a consequence, after air-drying, the fabric exhibits a surface tension of up to 34.4 mN/m^{48} , leading to considerable loss of oleophobic as well as hydrophobic properties. According to many authors^{151,152}, it is possible to recover the departed hydrophobicity partially or wholly after heat treatment.

Figure 20 shows the regeneration of the effectivity of the hydrophobic behavior after a heat treatment process, measured on different fluorocarbon-treated fabrics. Regardless of the

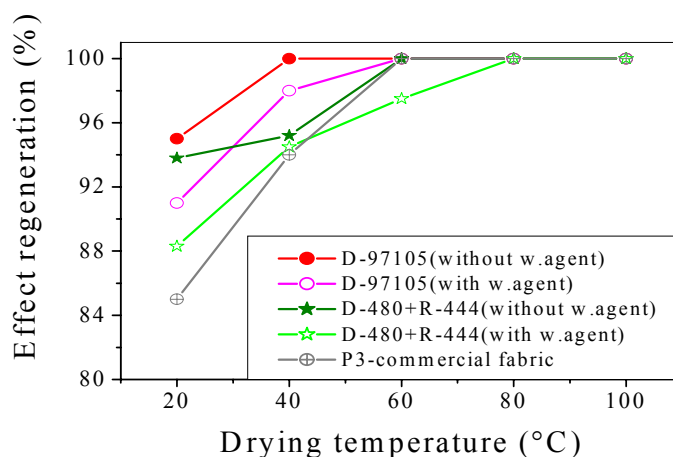

Figure 20 Recovery of the hydrophobic behavior as a function of heat treatment. Concentrations of fluorocarbons and wetting agent are 30 g/l and 3 g/l respectively.

origin of the products, a substantial loss of water-repellency was observed in all cases after washing but found to rise again by drying the materials afterwards. The changes in water-repellency caused by a fluorocarbon treatment occur not only on the outermost surface but also in to a depth of several hundred nanometers⁴⁸. It is assumed that washing and heat treatment cause rotation of the fluorine chains within polyester, being repelled by the hydrophilic environment during washing, and from inside to the outside during subsequent heat treatment¹⁵³.

The efficiency of the recovery process was not the same for all products, some of them have responded to heat quite early leading to regain the full efficiency of the polymer film at a temperature as low as 40°C. The heat treatment was most efficient when the temperature reached 80°C and the contact angle increased to the initial values of the respective products. At this temperature, which is the glass transition temperature of the bulk polyester, the fluorocarbon segments recover their mobility and form a new homogeneous fluorocarbon film at the fiber surface, masking the hydrophilic portions of the segments.

The effect of using a wetting agent along with the fluorochemicals should not be overlooked, whose application was found to affect the regeneration process. From Figure 20 it is apparent that the use of wetting agent led to a delayed recovery of the suppressed repellency requiring comparatively high temperature of drying. This could be explained with the polar nature of

the wetting agent. The presence of any extra polar molecules other than water might intensify the polar atmosphere slowing down the effect recovery process.

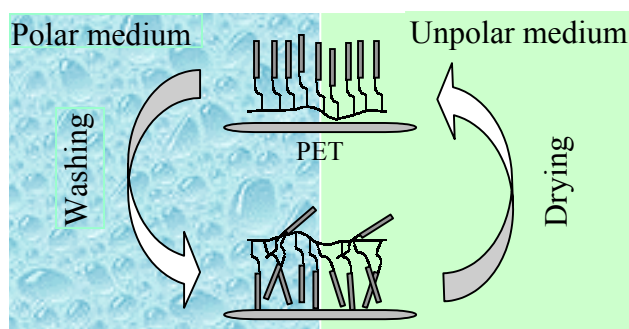

Figure 21 Reorientation of fluorinated segments by washing and heat dependency of the effect regeneration.

4.1.3.4 Ironing of the fabric

The reason fabrics are ironed is to improve aesthetics. In practice OP textiles are, as a rule, subjected to washing after each application. Washing causes not only the reorganization of the fluorocarbon moieties available on the surface, also introduces some changes in the physical properties of the fabrics generally leading to an unpleasant appearance of the fiber materials. Almost all apparel fibers are prone to shrinkage and wrinkle due to the action of water, therefore, it is needed to bring them into a wearable and crease free state. In doing so, the ironing technology is by far the most common technology used in household as well as in garments industry. In contrary to drying effect, the ironing process provides an additional mechanical action on the fabric, which might have some detrimental effects on the wetting behavior of the fabric surface.

For comparison, an effort has been conducted substituting the heat treatment by the ironing process. In respect of effect recovery of the fluorocarbon finish film, the ironing was found to be same in action but showed somewhat difference in ensuring the degree of output. The complete reorganization of the fluorocarbon resins was most likely be restored; nevertheless the hydrophobicity attained thereby was lower in magnitude. This undesirable effect-diminishing role played by ironing is to be explained by the “smoothing” of the fabric surface due to the mechanical action of this process aided by temperature (see later roughness effect). Figure 22 demonstrates the effect of ironing, in which both the contact angle and the sliding angle were compared measured on a fluorocarbon-finished fabric before and after the ironing process. Apparently, the ironed surface exhibits a lower contact angle confirming that the

wetting behavior of a particular surface get affected by ironing. A similar phenomenon was also observed by silicone-treated surface.

So far the evidence goes, silicone-finished fabrics are not susceptible to washing environments, i.e., no reorientation of the chemical moieties takes place during washing, hence they do not require any subsequent heat treatment as it is required in case of a fluorinated surface to get back the full effectiveness. This conception leads to the conclusion that it is the mechanical effect of ironing rather than heat that impaired the hydrophobicity of the surface.

Whilst the influence of ironing on hydrophobicity on a fluorocarbon-treated surface, as illustrated in Figure 22, is less pronounced in contact angle values, the measurements of sliding angle showed this effect even more explicitly. It was found that if a droplet of water is dropped on a fluorocarbon-treated surface that is not ironed but dried at recognizing temperature after washing and then it is allowed to be inclined slowly from its initial horizontal position, the water droplet starts to roll down already at an angle of inclination of 13° of the fabric. This was, however, not the case with an ironed fabric surface on that the water droplet moved obviously in a sluggish manner and rolled-off with an angle of inclination of approx. 20° .

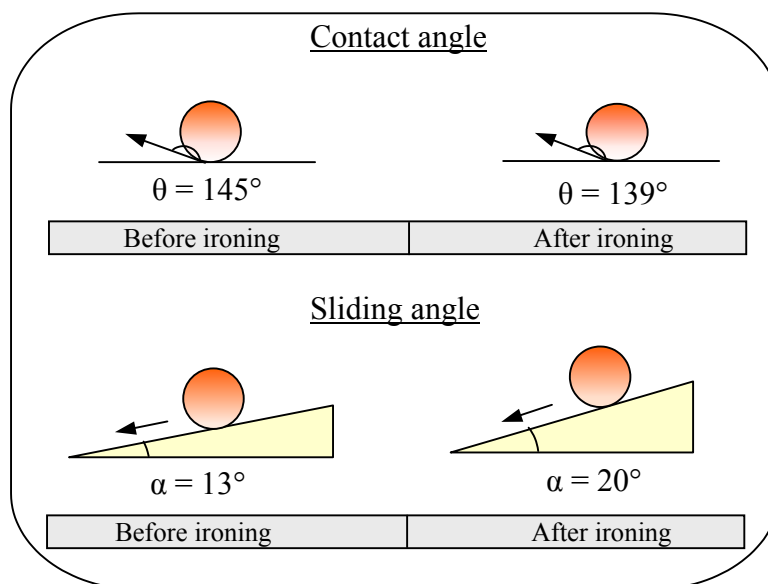

Figure 22 Effect of ironing on contact angle and sliding angle (FC, D-86071 = 30 g/l, pick-up% = 60%, drying = $100^\circ\text{C}/90\text{s}$, condensation = $160^\circ\text{C}/120\text{s}$).

4.1.3.5 *Alkali treatment of the surface*

It is well-known that the wettability of solid surfaces is governed by both the chemical composition and geometrical microstructure of the surface¹⁵⁴. As already described in the theoretical part, an ultra hydrophobic surface is obtainable by introducing proper roughness (by etching) on materials outfitted with low surface energies¹⁵⁶. Strong alkalis, such as caustic soda, etch the polyester fiber surface. Taking it into consideration, the fiber materials were treated with concentrated alkaline solution (250 g/l) at a temperature of 60°C for varying treatment times ranging from 10 to 30 min. The finishing process with given chemicals was accomplished thereafter.

As it is shown in Figure 23, the previously homogeneous smooth fiber surface got roughened due to the hydrolysis action of alkali, being prominent in extreme case (treated for 30 min) but the developed roughness was irregular and inhomogeneous and was not typical for the whole surface. Therefore, the expectation of improving the hydrophobicity of the surface by an alkali treatment was not achieved.

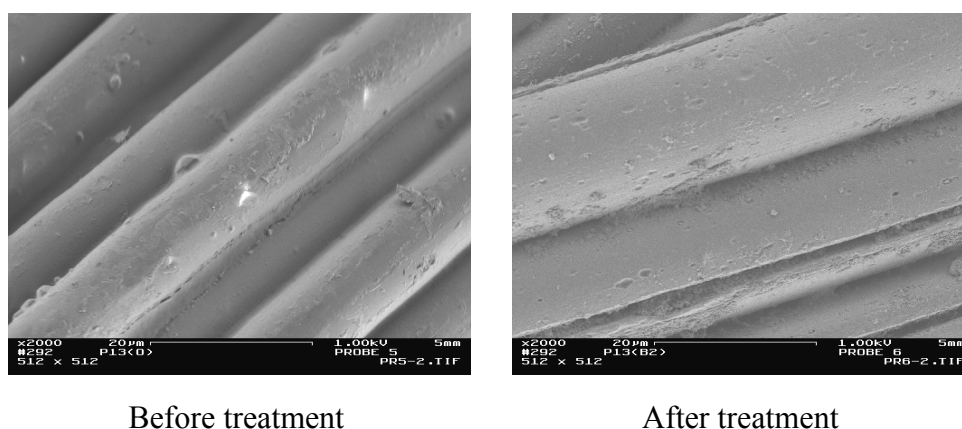

Figure 23 Surface roughening caused by alkali treatment.

The attempt of intensifying the hydrophobic behavior of the PET- surface by alkali treatment was, however, not in vain, since a pleasant grasp with excellent drapability and comfort of the fabric was achieved. Polyester fibers are susceptible to the action of bases depending on their character. Literatures available^{157,158} show that the ionisable base like caustic soda only affect the outer surface of polyester filaments. The carboxyl groups of the surface polymer is believed to be attacked in a random manner by hydrolysis action of alkali with removal of the shorter chains from the surface. The result is not only the improvement of the aesthetics but also accompanied by a remarkable decrease in fabric weight, yielding an almost similar effect to that of natural silk. In our cases, it was found that the weight reduction of the polyester fibers increased linearly with increasing alkali concentration and treatment temperature and

time. The fabric suffered a maximum weight loss of 8% by treating it with 250 g/l sodium hydroxide solution at 60°C for 30 min. Conversely, with increased weight loss, the tear strength of the fabric was found to be decreased only to a little extent.

The ester groups are prone to alkaline hydrolysis¹⁴⁶. Using this susceptibility to alkaline attack, efforts have been conducted to wash out the fluorocarbon compounds from the fabric to achieve again a hydrophilic surface. However, the treatment at room temperature even for a prolonged period of time showed no deteriorating action on the hydrophobic behavior. Heating the solution up to 40°C did not give optimum result, whereas when treating the material at a temperature of 60°C only for 10 min, the hydrophobicity completely disappeared indicating an effective and entire removal of the fluorocarbon groups from the surface.

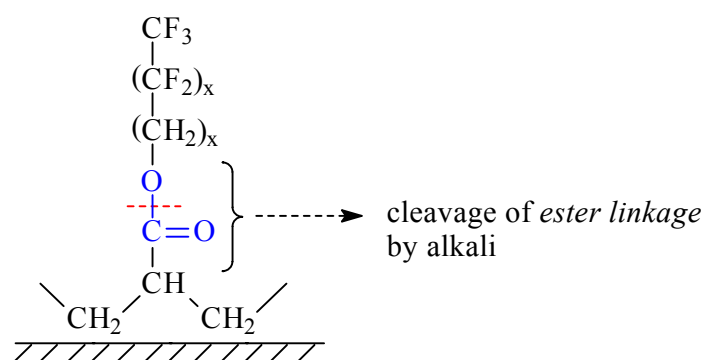

Figure 24 Decomposition of perfluoroalkyl chain of fluorocarbon compounds at ester linkage being attacked by hot alkaline solution.

4.1.4 Optimization results of wet-finishing agents

After optimization of the application parameters a comparative better performance of the selected fluorochemicals and silicones were achieved both in contact angle as well as in air permeability. Summarizing the preceding results, the fluorochemicals showed better repellency and the maximum contact angle was given by using the chemical D-86071 reaching the value up to 147°. The initial hydrophobicity measured on the silicone-finished surface was also found to improve to some degree applying the chemical under optimized conditions. However, its contact angle value was still lower than those attained by fluorocarbon resins but lagging not far behind. This somewhat lower hydrophobicity of silicone compound was not in contrast to expectations but also predicted from theoretical studies.

The highest values of contact angle acquired on the surfaces treated with selected fluorocarbon and silicone products under optimized conditions are presented in Figure 25.

These contact angles, which are nearly close to the value of an ultra hydrophobic surface (i.e., 150°) was, however, not possible to obtain by chemically alone. The combined effect of rough fabric surface and the incorporated hydrophobic groups made it possible to reach such high contact angles.

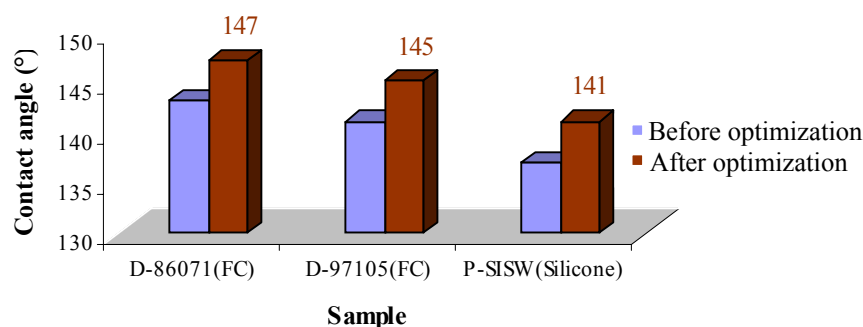

Figure 25 Highest contact angles achieved after optimization of application parameters (pick-up=60%, drying temp./time=100°C/90s, curing temp./time=160°C/120s).

Apart from the achievement of reasonably high contact angles, the basic expectation of retaining the air permeability of the original fabric was also eventually almost realized after execution of the optimization process. It was found that neither fluorocarbon nor the silicone compounds altered the air permeability of the bulk fabric to an extremely high degree. In particular, at first sight, it seemed that the fluorocarbon product, D-97015 would be inconvenient because of its disability of keeping the air permeability as good as the other two variants. However, this disadvantage has been overcome by providing the appropriate finishing environments that led to a significant enhancement of the air permeability (Table 6).

Table 6 Improvement in air permeability after optimization of treatment variables.

Finishing agent	Decrease in air permeability (%)	
	<i>Before optimization</i>	<i>After optimization</i> (pick-up=60%, drying temp./time=100°C/90s, curing temp./time=160°C/120s)
D – 86071 (FC)	15	10
D – 97105 (FC)	24	14
P – SISW (silicone)	17	13

While the contact angle of water has been commonly used as a criterion for the interpretation of hydrophobicity of the surface, this alone is not quite sufficient and does not define the sliding properties of a given surface¹⁵⁹. To interpret the hydrophobicity more explicitly, the rolling-off ability of water droplets was measured in addition to the contact angle. Since with

variation in droplet size the sliding angle varies showing almost a linear trend, the measurements of sliding angle were done with a constant volume of water droplet (10 μ l).

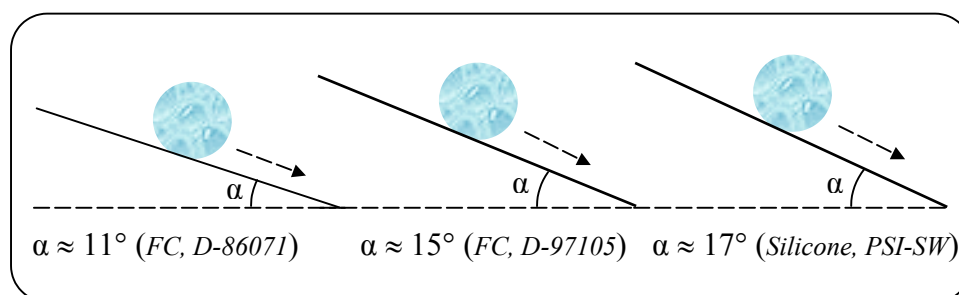

Figure 26 Variation in sliding angles (α) depending on the type of finishing materials used.

It has been found that in all cases the sliding behavior of the same surfaces was in good agreement with the contact angles obtained. A surface exhibiting higher contact angle also showed a corresponding lower sliding angle. The already demonstrated superiority of fluorocarbon compounds over the silicone-based chemicals in respect of hydrophobicity determined by their wetting behavior on a static surface was further ensured by sliding angle measurements (Figure 26). However, the reasonably high contact angles and accordingly low sliding angles were indicative of the certain surface roughness of the fabrics.

4.2 Plasma Modification

As an alternative approach, plasma enhanced fluorination using saturated fluorine compounds such as CF_4 and C_2F_6 has been carried out on the same PET fabric with a view to create an ultra hydrophobic surface. Prior to treatment the fabric was pretreated, i.e., desized in the similar way as it was done for the wet-finishing.

4.2.1 Treatment with C_2H_4 plasma

Extensive literature data indicate that CF_4 and C_2F_6 plasmas are characterized with simultaneous etching (ablation) and deposition or polymerization of the reactive plasma, the dominance of one process to another varies depending on the type of monomer used¹⁶⁰. Ethylene (C_2H_4) or H_2 is often found to be used as a mixing component with the intention to shift the balance from etching to polymerization.

Since ethylene itself is hydrophobic in nature and evidence available shows that ethylene plasma treatments generally lead to an extreme thin, highly cross linked, chemically inert and micro pore-free polymer surface¹⁶¹, in this work an attempt has been made to investigate to what extent the polymer surface could be hydrophobic modified if treated alone with ethylene plasma.

The results of variation in treatment times starting from 60 sec onward up to 240 sec depending on the different gas flow rates (50% and 100%) are recorded in Table 7 and 8 showing that the treatment time was not of significant influence causing almost negligible change in surface hydrophobicity. The nearly same magnitudes of contact angle and sliding angle were achieved in both cases with variation in treatment time.

Table 7 Hydrophobicity of C_2H_4 treated surface as a function of treatment time.

Gas flow (sccm) = 50%

Treatment time (sec)	Contact angle* (°)	Sliding angle (°)
60	126	Not measurable since the water droplet does not roll-off even at 90° inclination of the fabric surface
120	130	
180	134	
240	132	

*The standard variations for the contact angle measurements are typically 1-2°.

The effect of variation in flow rate of the ethylene gas was of particular significance. A 50% reduction in gas flow rate showed only a minor decrease in contact angle, whilst the increase in sliding angle was not measurable since the water droplet does not roll-off the fabric even at 90° inclination of the surface. By treatment with maximum, i.e., 100% gas flow rate, comparative better results were obtained, where the water droplets were found to roll-off by a certain degree of inclination of the surface.

Table 8 Effect of treatment time on hydrophobicity treated with C₂H₄ plasma.

Gas flow (sccm) = 100%

Treatment time (sec)	Contact angle* (°)	Sliding angle* (°)
60	132	57
120	133	55
180	136	47
240	134	57

*The standard variations for both the contact angle and sliding angle measurements are typically 1-2°.

However, the extent of hydrophobicity acquired in both cases seemed not to be very promising and also not high enough to meet the requirements as it is expected for a barrier fabric, which would, in fact, show no or very low adhesion to any approaching droplet of liquid.

4.2.2 Treatment with CF₄ plasma

Pure CF₄ plasma treatment is known to result in substrate etching rather than deposition of plasma polymer¹⁶². This is because of that CF₄ plasmas are characterized by high concentrations of F atoms and relatively low concentrations of CF_x radical species¹⁶³.

The experimental results for a maximum flow rate quoted in Figure 27 reveal that the hydrophobicity obtained with CF₄ plasma are somewhat analogous to those acquired with C₂H₄ plasma comparing the values of contact angle measurements. Nonetheless, a significant difference between these two treatments was in their sliding properties that were apparently noticeable by observing the rolling behavior of water droplets of equal volume placed on them. It was observed that the droplets of water assumed a more spherical shape on a surface treated with CF₄ plasma showing a better and spontaneous rolling ability even for a slight movement of the material position. This higher movability of the water droplets was reflected

well in the sliding angles, which were explicitly lower in magnitude for the CF_4 plasma-treated samples.

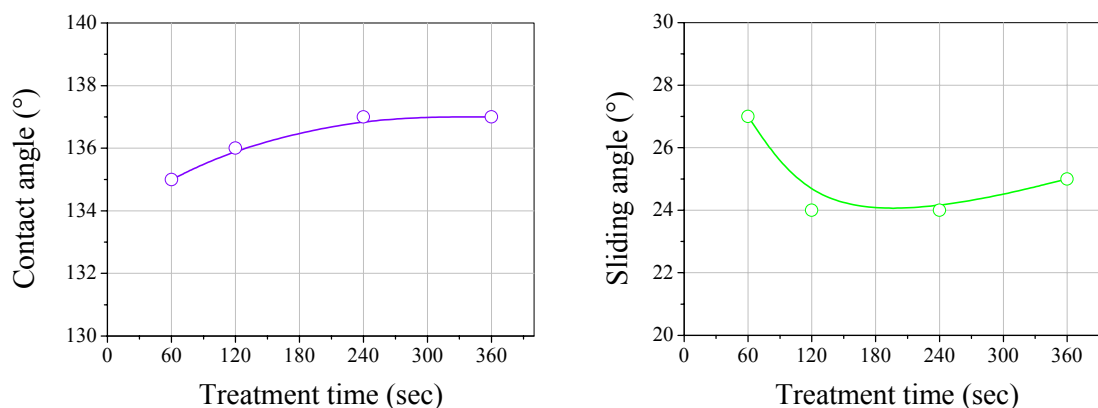

Figure 27 Treatment time dependence of hydrophobic effect for CF_4 plasma-treated fabric.

An overall evaluation of the results obtained by treating the samples with CF_4 plasma indicated that the CF_4 plasmas are capable to impart significant hydrophobic character to the fabric surface. In addition, the hydrophobic behavior developed thereby was negligibly influenced by the treatment time, although the surface treated for a minimum duration, i.e., for 60s showed the tendency to be less pronounced both in contact angle and sliding angle. This is to be best explained by the fact with the predominant pathways involving F atoms and CF_x species, whose degree of generation is most likely to be uncompleted and inadequate at a low time of treatment.

4.2.3 Treatment with C_2F_6 plasma

Whereas the CF_x/F ratio in a CF_4 plasma is relatively low, C_2F_6 plasmas are characterized by high concentrations of CF_x radical species and low number of F atoms¹⁰³. Therefore, of the two fluorocarbon gases studied, C_2F_6 is believed to polymerize. Aside from this, with higher CF_x/F ratio, by C_2F_6 plasma the mechanism of fluorination is dominated by the reactions of CF_x radicals, whilst it is governed by F atoms in case of a CF_4 discharge. This difference in chemical features and nature of fluorination is likely to cause different aspect of surface modification.

In our studies, as outlined in Figure 28, PET substrates treated in C_2F_6 discharges appeared to differ from the polymers exposed to CF_4 plasma to some extent. Clearly, the substrates treated with the former have higher contact angles as well as proportionally lower sliding angles despite having lower F/C ratios than the substrates exposed to CF_4 discharge. This higher

water-repellency reflects the large concentration of CF_3 and CF_2 groups on the surface treated with C_2F_6 plasma.

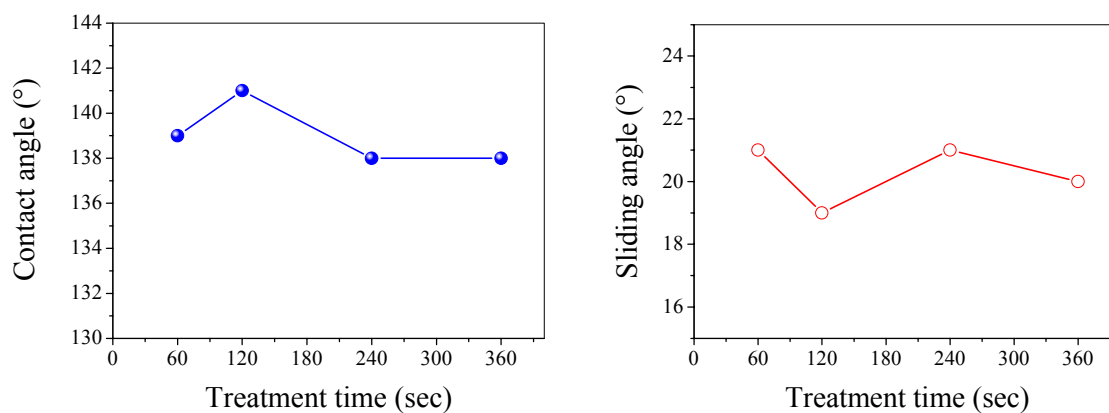

Figure 28 Contact angle and sliding angle on a C_2F_6 plasma-treated surface with variation in treatment time.

Comparing the hydrophobicity achieved on the surface modified with C_2F_6 plasmas, it was to notify that the course of variation both in contact angles and sliding angles with the variation in treatment times was almost identical. Thus, a high contact angle for a particular treatment time corresponded to a low sliding angle (Figure 28).

It was further to note that a prolonged exposure to plasma treatment did not bring any extra advantage; an improvement neither in contact angle nor in sliding angle has been achieved. As stated earlier, the treatment for a short time (60s exposure) may account for insufficient fluorination of the surface. Treating the material for 120s seemed, however, likely to be auspicious and therefore, could be taken as standard for the further experiments to eliminate the probable risk of inadequate generation of fluorocarbon species on the surface as well as to avoid undue effects caused by excessively long period of treatment.

4.2.4 Treatment with $\text{H}_2/\text{C}_2\text{F}_6$ plasma

One commonly held belief about fluorocarbon plasmas is that saturated fluorocarbons polymerize more poorly than unsaturated (and cyclic) fluorocarbons⁹⁴. In order to form a polymer from a saturated perfluorinated compound, the elimination of F atom from the monomer to create a site to form a new C – C bond and the efficient removal of highly reactive F atom from the reaction system are two important requirements. One way to achieve these two steps efficiently is to add reducing agents such as H_2 , C_2H_4 etc. into a plasma of perfluorocarbons¹⁶⁴. The increased degree of polymerization caused by addition of reducing

agent is supposed to enhance the wash-stability of the modification, which is one of the important elementary parameters for a reusable operation clothing.

To investigate the extent of influence on wettability caused by adding H_2 to the feed a series of experiments were designed. Starting with a minimum fraction of H_2 , its portion in the mixing was stepwise increased proportionally decreasing the amount of C_2F_6 . For comparison, a treatment of the substrate was also carried out using only C_2F_6 as feed gas.

As shown in Figure 29, a significant increase in contact angle and corresponding decrease in sliding angle was reached with a pure fluorocarbon feed, indicating extensive incorporation of nonpolar groups in the surface after plasma treatments. As soon as H_2 was added to the mixture, a mild decrease in contact angle and a substantial rise in sliding angle was to be marked. This change in hydrophobicity was found to be a trend within the examined range, i.e., the higher is the amount of reducing agents in the feed composition, the inferior is the hydrophobic behavior revealing that a H_2 -containing feed leads to a surface with higher surface energy.

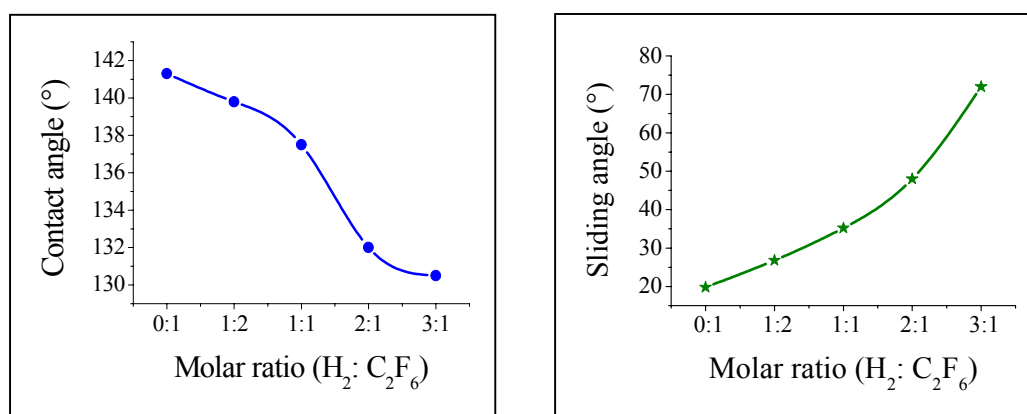

Figure 29 Contact- and sliding angles as a function of feed composition of H_2 and C_2F_6 – plasma (treatment time 120s).

In order to get a closer picture of the phenomenon regarding diminishment of hydrophobic action caused by H_2 addition, in addition to contact angle and sliding angle measurements, a measure of the surface tension of the modified surface was also executed. Though the values of surface tension is deduced from the results of contact angle measurements, it provides, however, some additional information such as quantitative details of the polar as well as the dispersive proportion of the surface tension.

From the theoretical point of view, an increase in polar contents in a given total surface tension would intensify the cohesive interaction of the surface preventing an easy sliding of the water droplets dropped on it. The reverse is also true. A rise in dispersive surface tension

would reduce the cohesive force between the surface and the polar liquid causing a rapid rolling down of the droplet.

Textile materials are inherently porous, containing many fine capillaries. Besides, they are characterized by rough surface topography, which made it difficult to measure the surface tension especially with the liquid of less polarity like diiodmethane. Hence, the measurements of surface tension were carried out on PET film instead of fabric. As described later (Figure 33), because of its smooth surface construction the PET film provides lower contact angle compared to the rough PET fabric surface.

As illustrated in Figure 30, the variations in surface tension with increasing amount of H_2 fraction in the feed were well in accord with the results obtained by contact angle measurements. An increase in H_2 content gave rise to surface tension of the substrate treated. From Figure 30 it is further to notify that the quantitative increase in polar components was lower than that of dispersive portions showing no abrupt fluctuation in course of their alternation. More specifically, the change in the content of polar surface tension did not show any sudden variation that could assist in explaining the dramatic changes in the sliding behavior of the surfaces caused by H_2 addition to the fluorocarbon feed.

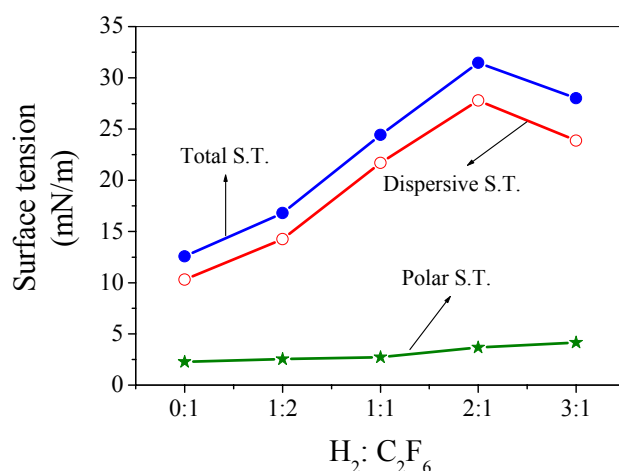

Figure 30 Surface tension (polar and dispersive components) of the deposited polymer surface on a PET film determined from contact angle measurements with water and diiodmethane.

4.2.5 Treatment with C_2H_4/C_2F_6 plasma

For authentication of the realized results by adding H_2 to a fluorocarbon feed, experiments were carried out again on the PET fabric using C_2H_4 in place of H_2 . In addition, the treatment of material was conducted in one-step as well as in two-step methods.

One-step method:

One-step method refers to the treatment of the substrate using a mixture of the precursor gases, C_2H_4 and C_2F_6 . For discrimination of the wetting behavior of the surfaces, the materials were exposed to a mixture of these gases under similar treatment conditions as it was accomplished in case of H_2 and C_2F_6 monomer gases. Both the treatments resembled also in their variation in feed compositions.

Since both C_2H_4 and H_2 are reducing agents, use of C_2H_4 instead of H_2 with C_2F_6 plasma could not result in any significant change in hydrophobicity. The extent of modification in both cases were almost identical. Analogous to H_2 mixture, it was found that with increased amount of C_2H_4 fraction in the feed composition the contact angles decreased gradually showing no abrupt change in values, whereas the sliding angles increased dramatically. Thus, in general, the hydrophobicity of PET surface decreased with an increase in the amount of H_2 or C_2H_4 gases in the fluorocarbon feed. These findings confirm the negative effect of reducing agents on the wetting behavior of the substrates and limit their use in higher quantity.

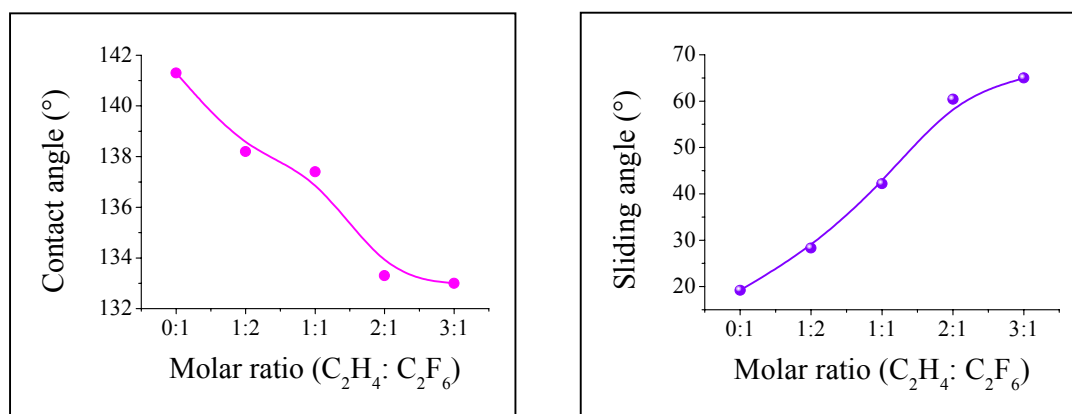

Figure 31 Changes in wetting properties of the PET fabric depending on the different feed compositions of C_2H_4 and C_2F_6 plasma gases (treatment time 120s).

Figure 31 depicts that the mixing of C_2H_4 even in a minimum quantity ($C_2H_4:C_2F_6 = 1:2$) affected the hydrophobicity of the surface, though the degree of deterioration was not severe. A further rise in the amount of C_2H_4 showed less viability to serve our purposes due to the substantial increase in sliding angles. Thus, a C_2H_4 dominated feed was found to be unfavorable as it was observed by a H_2 -containing C_2F_6 feed.

Two-step method:

Unlike H_2 , C_2H_4 is characterized by its dual nature of action. Apart from being a reducing agent, it is also inherently endowed with the ability to confer a reasonably high degree of hydrophobicity to the polymer surface (Table 7). By treating the material with C_2H_4 gas alone, the H species discharged under plasma conditions is insignificant and the action of hydrocarbons becomes prominent giving rise in hydrophobicity. In case of mixing with fluorocarbon plasma, it appears in a different mode of action. Presumably, its reducing activity predominates rather than its hydrophobic action, which is supposed to be suppressed by fluorocarbon species that are more hydrophobic in nature.

The reducing nature is, however, less effective or becomes completely inactive treating the material with C_2H_4 prior to C_2F_6 plasma. Therefore, it can be presumed that a separate treatment of the materials with these gases might lead to different outcomes. In support of these theoretical views, in addition to the treatments with gas mixtures a two-step technique was applied.

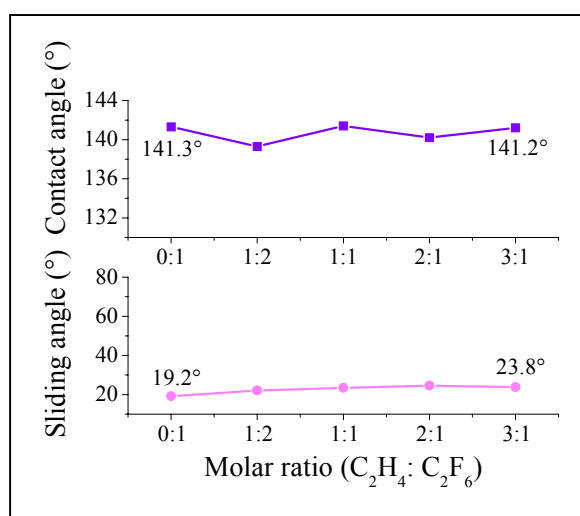

Figure 32 Effect of two-step treatment with C_2H_4/C_2F_6 -plasma on the extent of hydrophobicity depending on the molar composition of the feed gases (treatment time 120s).

As assessed, a two-step treatment appeared to be quite promising in modifying the surface characteristics. The variations in feed composition was found to exert negligible influence on the extent of hydrophobic modification of the substrate compared to the treatment with C_2F_6 alone. Both the contact angles as well as the sliding angles remained almost constant with increasing amount of C_2H_4 in the feed composition.

From economic viewpoint, this method seemed also to be viable. Since C_2H_4 is cheaper than C_2F_6 and its increased quantity in the feed was found to confer almost the same

hydrophobicity compared to the treatment with a pure C_2F_6 or a C_2F_6 dominated plasma ($C_2H_4:C_2F_6 = 1:2$), an extreme C_2H_4 dominated feed ($C_2H_4:C_2F_6 = 3:1$) can also be used to reduce the cost of production.

4.2.6 Influence of surface structure on plasma modified surfaces

A surface is defined as that part of an object that affects or can be affected preferentially by any modification. All objects have surfaces through which they communicate with their surroundings. The properties and structure of the surfaces are therefore of obvious importance. Fabric surfaces are unique and distinctively designed among solid surfaces in that they are uneven and rough in structure, while a polymer film, in general, possesses a reasonably smooth appearance. The irregularity in fabric surface determines many of their practical characteristics. Examples of properties affected thereby include adhesion, wettability, friction, coatability, permeability, gloss, dyeability and biocompatibility¹⁴⁸. The ability to introduce chemical functionalities and nanoscopic structures to surfaces and interfaces offers the potential for the fine-tuning of the surface properties.

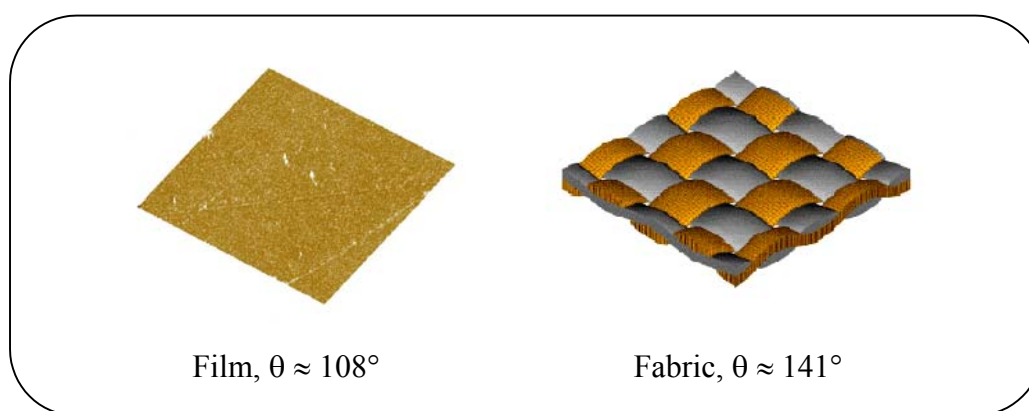

Figure 33 Effect of surface structure on hydrophobicity treated with pure C_2F_6 plasma (treatment time 120s).

Theoretical studies suggest that hydrophobicity depends on both the intrinsic material properties and surface morphology¹⁶⁵. The results obtained from our experiments were also not different and did agree quite well with the theoretical observations. Figure 33 and 34 represent the degree of hydrophobic modification measured in form of contact angle depending on the surface pattern as well as the cross sectional shape of filaments.

For comparison, a PET film surface was treated with pure C_2F_6 plasma, which was found to be moderately hydrophobically modified showing a contact angle of only 108° . Interestingly,

the application of the same plasma gas under similar treatment conditions on PET fabric caused abrupt change in hydrophobicity raising the contact angle as high as 141° (Figure 33). This increase in contact angle can be explained by an increase in surface roughness of the material.

Detailed studies indicate that in order to obtain a higher contact angle, it is necessary to reduce the contact area between liquid and solid¹⁶⁶. While for a PET film the hydrophobic behavior is alone attributed to the incorporation of fluorocarbon moieties, the fabric surface combines this chemical effect with its own rough topographical structures. The combination of both properties led to drastic reduction in the contact area between solid particulates of fabric and droplets of water. Thus, the interaction between fabric surface and water was significantly reduced, which resulted in the improved hydrophobicity.

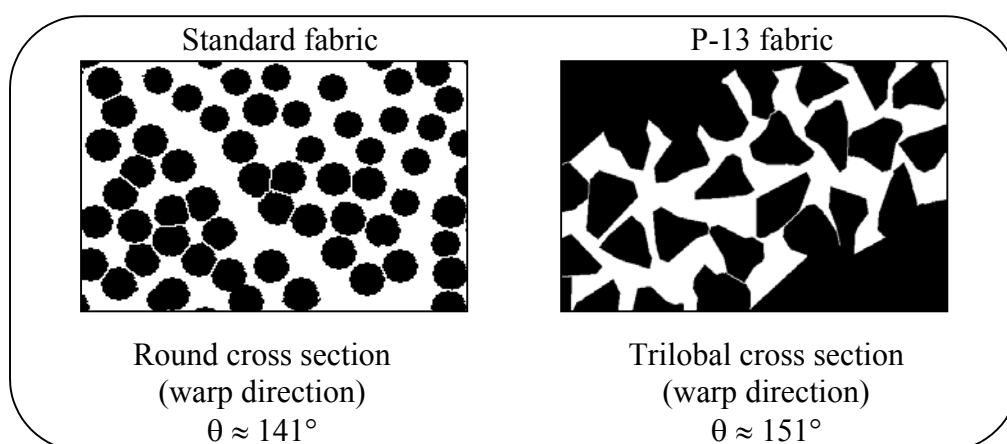

Figure 34 Variation in contact angle depending on the cross sectional shape of filament treated with pure C_2F_6 plasma.

Figure 34 shows further that the wettability is governed not only by the surface design but also by the cross sectional form of filaments. To carry out this investigation, in addition to standard PET fabric the similar treatment was also given to another commercial PET fabric namely P-13 (see experimental part). The fabrics differ from each other in respect of their filament cross section. While both the warp and weft filaments of standard fabric possess the simplest and familiar pattern, i.e., a circular cross section, the filaments of P-13 have also the similar cross section in the weft direction of the fabric but its warp filaments exhibit, on contrary, a modified trilobal cross section as shown in Figure 34.

It was found that this change in cross sectional architecture from round to trilobal resulted in increased hydrophobicity raising the contact angle from 141° to 151° . This increase in contact angle suggests that by varying the fundamental design of filament cross section the surface roughness can be further enhanced.

4.2 Physico-Chemical Characterization

4.3.1 Washing permanence

Reusable surgical gowns for the attempted application have to be washed and sterilized repeatedly. Therefore, in addition to keep the fabric in its original state without affecting the initial textile physical properties, a certain degree of wash-stability of the hydrophobic treatment is also a prior demand.

The durability of effects of surface treatment is highly dependent on the extent of short range (rotational) and long range (diffusional) mobility of polymer segments near the surface which are influenced by the polar environments of washing. The lack of durability often can be attributed largely to the surface rearrangement of macromolecular segments, which may be truly physical or in extreme cases loss of chemical functional groups¹⁶⁷. In this work, the decay characteristics of surfaces treated with wet-finishing chemicals as well as fluorocarbon plasmas were investigated after a series of washing treatments followed by contact angle and sliding angle measurements.

Experimental results presented in Figure 35 show that after 20 times washing the surface properties modified with fluorocarbon chemicals were only moderately affected, the effect reduction being less pronounced with D-86071 indicating considerably stable hydrophobic

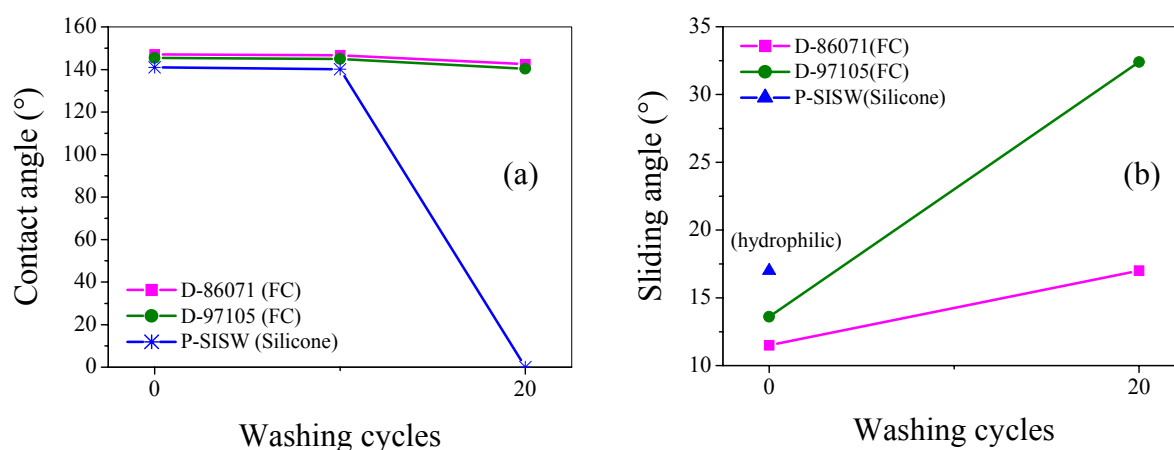

Figure 35 Effect of washing on the hydrophobicity treated with wet-finishing chemicals: (a) contact angle, (b) sliding angle.

surface. This low sensitivity to washing liquors of fluorocarbon chemicals is probably attributed to their high cross linking ability with the polymer surface.

On the other hand, treating the materials with silicone-based compounds with the objective of achieving a wash-stable surface was not realized. Whilst after 10 times washing no drop in contact angle was found to occur, a complete loss of hydrophobic behavior has been

surprisingly taken place after further 10 times washing. Two possible mechanisms may account for this sudden fall in effectiveness. The most likely explanation of such behavior is the disruption of the main polymer chain in some way and thus, the removal of the silicone compounds and the diffusion into water¹⁶⁸. An alternative hypothesis is based on the assumption that they may move or turnover into the bulk during immersion into water¹⁶⁹, which is a well-known characteristics to fluorine-containing groups. If it were due to the second mechanism, the effects would have been fully or partially restored in course of time or after a subsequent heat treatment. Neither by keeping the material in atmospheric conditions or by heating afterwards the hydrophobicity has been revived in our case that cancels out the second explanation and indicates a permanent loss of this property.

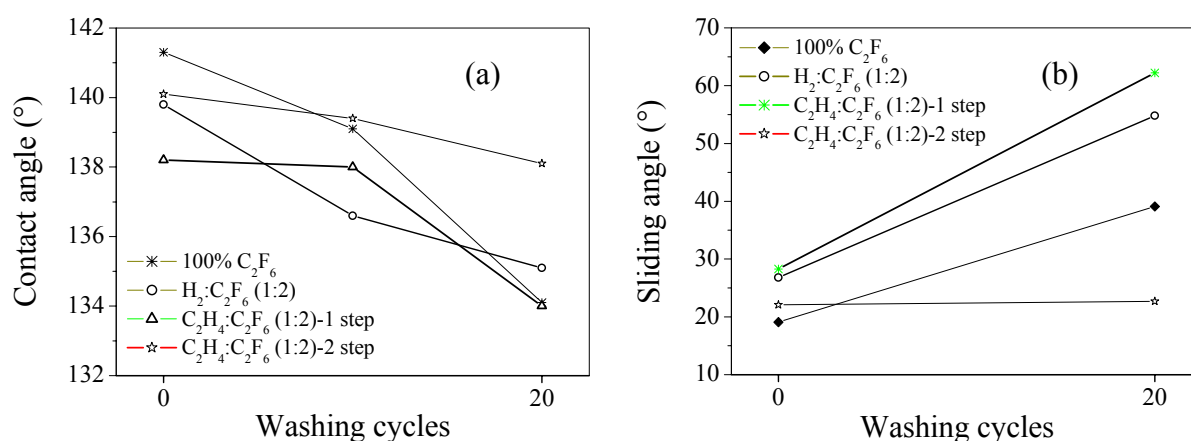

Figure 36 Effect of washing on the hydrophobicity of the plasma treated fabrics: (a) contact angle, (b) sliding angle.

It was observed that the samples modified with pure CF₄ plasma showed no resistance to washing treatment. After washing the materials only for 1 time, the hydrophobicity totally disappeared, hence this sample was not included in the graphical representation. This observation indicates the poor cross linking ability of pure CF₄ plasma.

On the contrary, pure C₂F₆ treated surfaces showed better resistance to washing, although some reductions in the hydrophobic character has been recorded indicating the removal of some of the nonpolar groups from the surface. Nearly similar effects were also observed by treatment with gas mixture as shown in Figure 36(a), while Figure 36(b) demonstrates a sharp increase in sliding angle referring to that the mixing of reducing agents (H₂ or C₂H₄) with the C₂F₆ plasma in small quantity does not confer strong adhesion property to the fluorine containing species on to the fiber polymer as it is achieved by separate treatment with the same feed gases.

Considering the degree of hydrophobic nature manifested by both contact angle and sliding angle measurements, it was apparent that by treating the PET fabric surface with C₂H₄

followed by C_2F_6 plasma, the durability of the modification can be greatly enhanced. Such improvement in durability of the hydrophobic property is postulated to be caused by the higher degree of cross linking¹⁷⁰ produced by virtue of prior application of an extremely thin layer of plasma polymer of ethane. The increased cross linking is supposed to inhibit the rotational and diffusional migration of hydrophobic moieties from the surface¹⁷¹ under the hostile environments of washing rendering outstanding stable surface.

4.3.2 Air permeability

As it is already found (Table 4) that the wet-finishing chemicals, in general, reduce the air permeability of the fabric. For comparison, the air permeability of the bulk after different plasma modifications was also measured. Figure 37 shows the decrease in the air permeability of the fabric modified with a pure C_2F_6 plasma compared to the treatment with a fluorocarbon (D-86071) and a silicone (P-SISW) chemical.

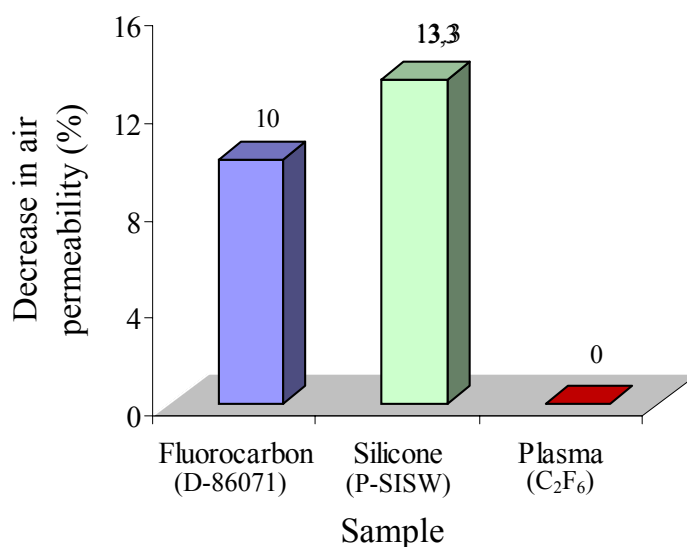

Figure 37 Different methods of modification with corresponding decrease in air permeability of the fabric.

As it is evident from Figure 37, the fluorocarbon-treated surface showed a very low decrease in air permeability. The finished fabric has retained 90 percent of the original air permeability of the uncoated fabric showing that the fluorocarbon finishing cover only the fiber surface¹⁷² leaving the interstices between warp and weft substantially unaltered.

On contrary to fluorocarbon chemicals, the selected silicone product (P-SISW) was found to reduce the air permeability slightly higher than that of the fluorocarbon one, which can be correlated with the fact that the silicone compounds cover up the fabric surface down to the

level of each single fiber³⁰ causing a homogeneous and closed structure of the fabric surface¹⁷³.

Whereas the wet-finishing chemicals made the surface hydrophobic leaving a thin polymer film on the fibers and yarns, plasma treatment results in surface reactions, e.g., etching and deposition of the reaction products of the plasma¹⁶². There are many interactions that take place during plasma processing between the reactive plasma and fabric surface, but these interactions and reactions were not accompanied by any decrease in air permeability of the treated materials. Irrespective of the monomer gas, feed composition and mode of treatment, the air permeability of the original fabric and the treated fabrics were exactly the same for all plasma treatments done in this work.

4.3.3 Ageing properties

It is already recognized since long that polymer surfaces and interfaces are mobile and will rearrange or reorient in response to the surrounding environment¹⁷⁴. This points out that the modification of the surface may not permanent and can undergo changes progressively, depending on the storage conditions and how firmly the reactive elements are anchored to the surface.

Figure 38 displays the ageing process of the modified surface for four different samples kept at room temperature. It is immediately to observe that the altered polymer surface caused by CF_4 plasma treatment is somewhat susceptible to the environments showing a small decrease in contact angle in the course of a week of storage at ambient conditions. Surface treated with C_2F_6 discharge behaved also in a fashion almost analogous to CF_4 plasma. In both cases, no further deterioration of hydrophobicity occurred for increased time of exposure with the contact angles remaining more or less the same until at least 30 days.

The decrease in hydrophobic nature after the first phase of exposure can be ascribed to surface reorientation due to lack of cross linking ability of these two precursors: unfavorable interfacial energies associated with the presence of polar groups at the interface with air provides a driving force that displaces modified polymer chains from the surface into deeper regions of the polymer¹⁷⁵, with consequent reduction of hydrophobicity.

The reason for unaltered contact angle after 7 days exposure is unclear, it can, however, be explained with the fact that the surface restructuring proceeded so far and no further; only some of the attached fluorine moieties being short segmented or more particularly, oligomers of fluorocarbon that can also cause changes in the surface hydrophobicity in excess of fluorocarbon polymer⁹⁴ have migrated away from the interface probably due to their much lower degree of cross linking or adhesion. Most of the other nonpolar groups were firmly

bound to the surface, presumably by adjacent cross links and therefore, prevented from migrating away from the polymer interface showing independency on the duration of storage. Due to their inflexibility, the surface did not respond to the atmospheric conditions any more that was reflected well in contact angle measurements conducted after a couple of weeks.

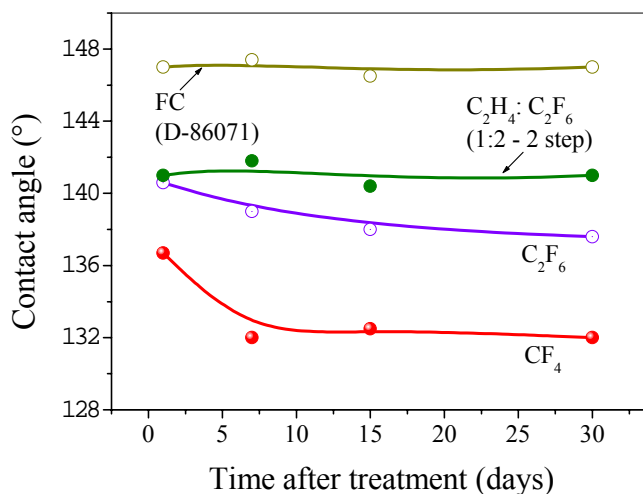

Figure 38 Ageing process (in terms of water contact angle) of hydrophobically modified surface, stored in normal atmospheric conditions.

If the deposited material is a typical plasma polymer, which has a certain degree of cross linking and good adhesion to a substrate, the hydrophobicity should remain constant. As already stated, addition of reducing agents in a fluorocarbon discharge leads to substantial increase in polymerization conferring increased cross linking. This effect is readily to observe from Figure 38 by treating the substrate with C₂H₄ prior to fluorocarbon treatment. The hydrophobic character obtained thereby did not decay with time. As expected, a closely similar behavior was also existed for fluorocarbon finishing compound being further indicative of higher degree of cross linking for this finishing agent (D-86071).

4.3.4 Tensile strength

Tensile strength is a mechanical property to measure the maximum force that the material can support before rupture. In practice, textile materials are often subjected to many mechanical operations during the transformation of fiber to fabric and during the manufacture of the final product be it garment, upholstery or whatever. It is, therefore, important for textile fibers to be characterized with sufficient tensile strength to withstand such operational compulsions. In order to define how far the tensile strength of polyester micro fibers gets affected by the

applied tools of surface modification, the treated materials were mechanically tested to assess their stress-strain behavior.

Though polyester fibers possess diverse mechanical characteristics, its strength is, however, not extraordinarily high and needed therefore like other fibers an extraneous safeguard to sustain the vigorous action of processing. Commercial sizing materials are commonly found to be used to strengthen the yarns. Hence, the decrease in strength of the bulk material after desizing the sized yarn as shown in Table 9 was highly consisted with the expectation.

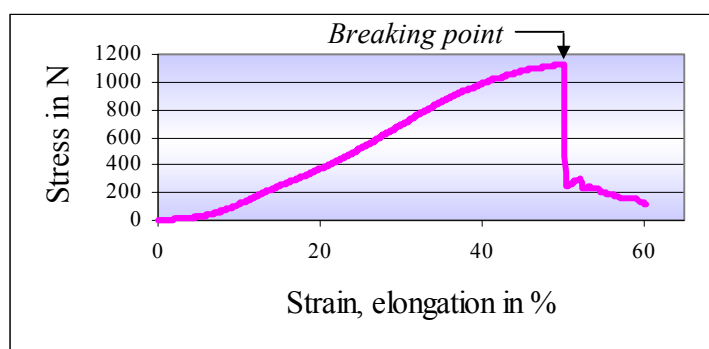

Figure 39 Stress-strain curve for silicone finished (P-SISW) polyester micro filament fabric.

The most striking feature of the results obtained from these experiments was the restoration of the fabric strength after a fluorocarbon finish with D-86071. This restoration of tensile strength is attributable to the thin resin film of fluorocarbon polymers left on the textile fibers. On contrary, the silicone product (P-SISW) was also found to increase the strength of the fabric to some extent and could not restore the total strength as it was regained by fluorocarbon.

Table 9 Force required to break and proportional elongation of different fabric samples (clamp-length of specimen = 100 mm, rate of stretching = 100 mm/min).

Fabric sample	Elongation at break in (%)	Force (stress) at break in N
Original (contains sizing material)	42 ± 1	1158 ± 16
Desized	47 ± 1	1074 ± 11
Fluorocarbon finished (D-86071)	55 ± 5	1159 ± 15
Silicone finished (P-SISW)	51 ± 3	1117 ± 12
Plasma (100% C ₂ F ₆) treated	46 ± 2	1077 ± 17

In comparison to the wet-finishing methods referred to above, treatment with pure C_2F_6 plasma did not alter the tensile strength of the fabric. Both the desized and the treated fabric were found to sustain almost the same mechanical force before rupture. Such unaltered tensile property of plasma-treated fabric was, however, in good agreement with the expectation, since the action of plasma modification is essentially confined to changing in surface chemistry, which undergoes no or very minor change in fundamental structure of the yarns.

Of not lesser importance was the percent elongation of the fibers at break. The application of sizing materials on the yarns was found to reduce their strain property compared to desized yarns by around 5% (Table 9). This reduction in elongation at break can be assigned to the synthetic resin film formed by the sizing chemicals that are at large hard and brittle in nature. The removal of such harsh coatings had a natural consequence of higher elongation of the fabric. Whereas a further improvement in strain behavior of the substrate by finishing with wet-chemical compounds was to be observed, plasma treatment did not give any rise to fiber elongation at break.

4.3.5 XPS-analysis

The chemical structure of the PET film surfaces was analyzed by XPS. The power of XPS lies in the quantification of the surface elemental composition. In many cases it also helps to determine structural features and their concentrations¹⁷⁶ in the surface of the material.

Wet-finishing

Figure 40 shows the C 1s spectra for untreated and fluorochemicals-treated PET fabric surfaces, where it is clearly to see that the C 1s spectrum for untreated PET contains three distinct peaks. These peaks can be assigned to the carbon atoms of the phenyl ring (*A*), the methylene carbon atoms singly bonded to oxygen (in the case of PET mostly $\underline{C}-O-C=O$ bond, indicated by *B*), and the ester carbon atoms ($C-O-\underline{C}=O$, indicated by *C*)¹⁶². The excess of the component peak *B* shows that processing aids of the fabric formation process are also adsorbed on the PET surface.

After the treatment with fluorocarbon compounds, the C 1s spectrum showed five distinct peaks, where the new two peaks can be assigned to $-CF_2-$ and $-CF_3$ groups¹⁶². These groups, due to their inherent low surface energy, endowed the fabric surfaces with the ability to repel the water molecules.

In untreated fabric sample, a tiny signal of fluorine was detected. The presence of such small amount of fluorine entity prior to fluorocarbon treatment is unusual and relates most likely to contaminants from handling or processing. However, these traces of fluorine species did not

exert any influence on the surface properties of the fabric and can be therefore largely ignored.

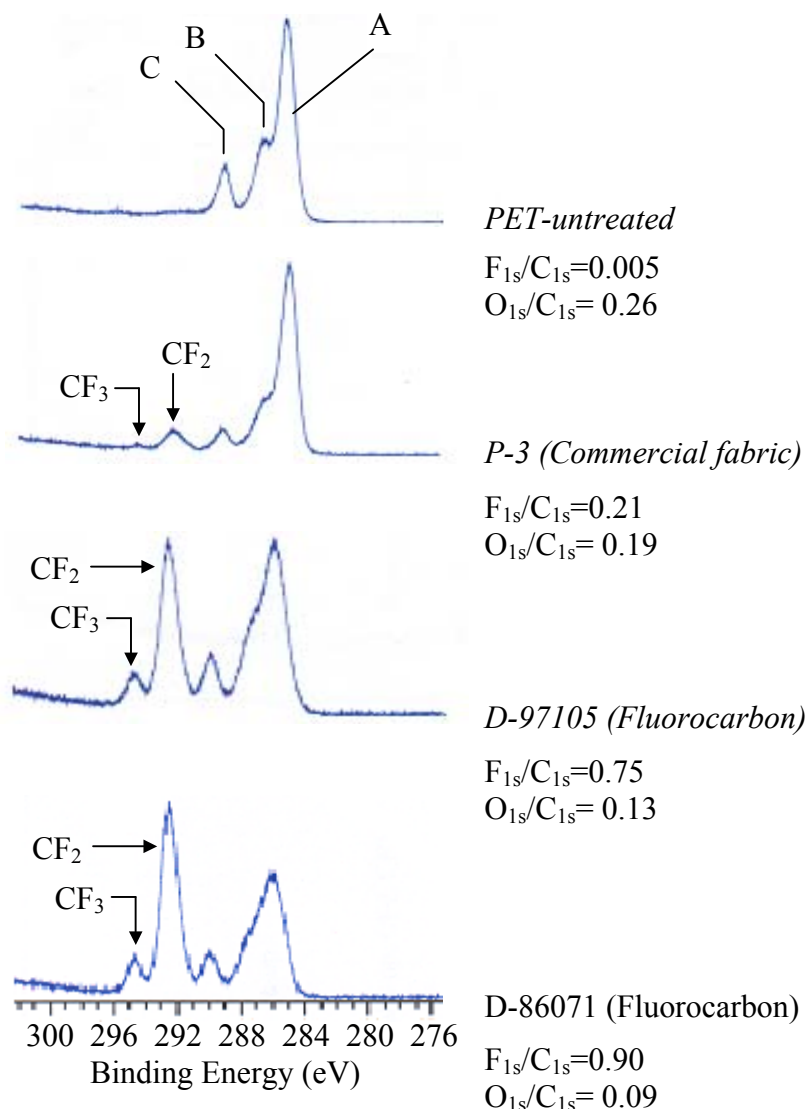

Figure 40 Carbon 1s ESCA spectra of untreated and fluorocarbon-treated polyester micro filament fabric.

P-3, a commercially finished fabric, was investigated as a reference to compare the degree of fluorination as well as the wetting characteristics of the surfaces treated with selected fluorocarbon compounds. The emergence of two fairly small peaks of CF_2 and CF_3 groups on P-3 surface was a first indicative of a fluorocarbon treatment of the fabric. Further on, they hint to the fact that a substantial incorporation of fluorocarbon moieties was not achieved by such commercial finishing.

The C 1s spectra of the surfaces modified with selected fluorocarbon compounds shown in Figure 40 reveals immediately that the newly formed polymer structure derived from D-97105 system was superior in terms of introducing a significant amount of perfluoroalkanes to the commercial one. The incorporation of these groups, which are decisive for wetting nature of a surface, was further confirmed by applying the second variety of chemical, i.e., D-86071. The C 1s spectrum of the surface treated with the former product did show a much larger signal intensity of CF_2 structural features than the CF_3 features and a similar situation was also encountered for the latter one, which correlates very well with the chemical composition

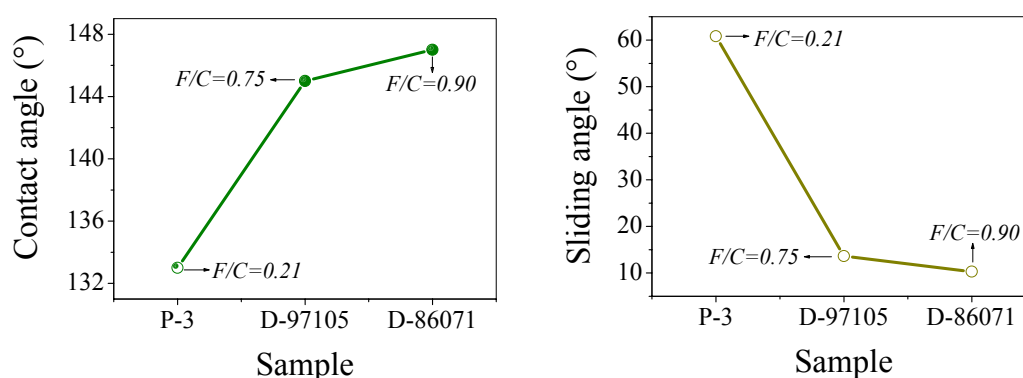

Figure 41 Variation in F/C ratio affecting the wetting and sliding behaviour of PET fabric surfaces treated with different fluorocarbon products.

of the products where more CF_2 species ($C_5 - C_8$) exist than CF_3 . Both of such treatments led to an extensive surface fluorination raising the F/C values from 0.005 (untreated PET) to 0.75 and 0.90 respectively. Other than the insertion of fluorine entities, a parallel decrease in oxygen quantity was also apparent. This decrease of oxygen may be because of the fact that the polymer surface is covered with the layer of CF_2 and CF_3 species. A higher hydrophobicity can be correlated with a compact and thicker fluorocarbon layer formed on the surface. Since the analysis depth of XPS is maximum 10 nm (Figure 45), in case of a thick layer the beam of x-rays confines mainly in the layer developed and measures the PET substrate to a lesser extent compared to a thin film. Thus, the detected amount of oxygen is reduced in case of a thicker fluorocarbon layer (e.g., D-86071) developed on the polymer surface.

The effect of higher F/C ratio on wetting properties of surfaces can be simply verified with contact angle and sliding angle measurements, which are well documented in Figure 41. At first glance, it is easily identifiable that the results of such measurements in all cases were entirely consistent with results of XPS-analysis of the surfaces.

Clearly, on the fabric surface treated with the commercial fluorocarbon chemicals a reasonably high contact angle was achieved, while for P-3, it fell to a minimum. This increase

in contact angle applying selected compounds was a reflection of the introduction of hydrophobic groups on the surface in a relatively high quantity and demonstrated that the right choice of finishing agents offers much room for optimizing the hydrophobic barrier.

Not surprisingly, the anticipated sliding behavior of the surfaces were in good agreement with their wetting properties showing that the sliding angle increases with a decreasing F/C ratio, e.g., for P-3, which contained the lowest F/C ratio, the sliding angle (60°) was not as low as for the ones ($10 - 15^\circ$) with a high F/C, e.g., D-97105 and D-86071.

Plasma modification

PET substrate treated in C_2F_6 discharge is easily distinguishable by XPS measurements from the untreated one by the emergence of two fairly strong fluorocarbon peaks (Figure 42). Similar to wet-finishing compounds, C_2F_6 plasma produced unequal amount of CF_2 and CF_3 groups, where the generation of the former entity was higher in both cases. The films exposed to a C_2F_6 plasma have comparable contact angles despite having lower F/C ratios (determined by XPS) than the fabric materials modified with fluorocarbon based wet-finishing chemicals. This lower F/C ratio does not essentially indicate the generation of F species is lower by C_2F_6 plasma than that of fluorocarbon finishing. The reason might be the thin CF_x layer developed by C_2F_6 plasma. As already stated, a thin layer has lower coverage of the substrate, which leads to measure also the C species of PET material by XPS. Thus, a higher analysis depth of XPS results in lower F/C ratio.

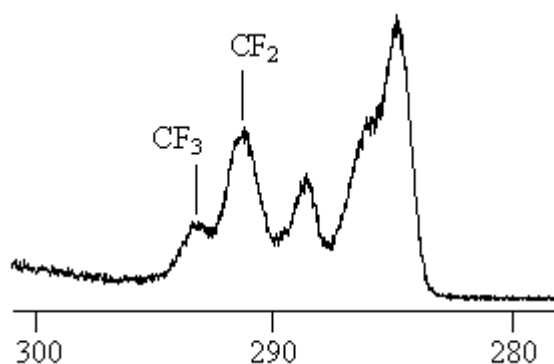

Figure 42 Carbon 1s ESCA spectra of C_2F_6 plasma-fluorinated PET film.

Table 10 lists the changes in atomic percent composition in the surface of PET film determined by XPS after C_2F_6 plasma treatment. The results obtained demonstrated once again an extensive incorporation of nonpolar fluorine atoms in the surface after the plasma treatments. The treatment resulted in decrease in O/C ratio, while the F/C and F/O ratios increased up to 0.49 and 3.55 respectively.

Table 10 The elemental composition in untreated PET film surface and treated with C_2F_6 plasma determined by XPS.

Sample	Elemental composition (XPS atomic ratio)			
	N/C	O/C	F/O	F/C
Untreated	0.01	0.27	0	0
Treated with C_2F_6	0.01	0.14	3.55	0.49

The changes in surface characteristics caused by mixing of a reducing agent with a C_2F_6 plasma has also been investigated by means of XPS-analysis. Figure 43 shows clearly that if a fluorocarbon dominated in the feed (the mixing ratio of C_2H_4 to C_2F_6 is 1:2) higher F contents and lower O and C contents were obtained. Upon further addition of C_2H_4 to the feed, a gradual decrease in the intensity of the peak for F 1s and a simultaneous increase in the peak for C 1s was observed.

Table 11 depicts the results of atomic ratios of C_2H_4/C_2F_6 plasma polymers obtained thereby. An explicit inverse relationship was observed between the amount of reducing species in the feed composition and the content of fluorine atoms in the treated surface. The higher the proportion of C_2H_4 fraction in the mixture, the lower was the F/C ratios. In a similar trend, it was found that any addition of C_2H_4 caused gradual reduction in the of F/O ratios in the surface. These results are in perfect accordance with the results of hydrophobicity of the modified surfaces manifested by contact angle measurements.

Table 11 Relative atomic composition determined by XPS and contact angles of the surfaces treated with different mixing ratios of C_2H_4/C_2F_6 feed gases.

Monomer composition	Relative atomic concentration (%) (PET film)			Contact angle (°)	
	O/C	F/O	F/C	PET film	PET fabric
$C_2H_4: C_2F_6$					
1:2	0.04	12.42	0.52	106.2	138.2
1:1	0.06	2.98	0.20	103.2	136.4
2:1	0.04	2.60	0.10	82.9	133.3
3:1	0.03	1.63	0.05	78.0	131.8

Treatment of the material in two stages, instead of any gas mixture, i.e., first with C_2H_4 and immediately after that with C_2F_6 resulted in a tremendous surface modification. Irrespective of the feed composition there was a substantial incorporation of fluorocarbon atoms in the surface. As Figure 43 demonstrates, the intensity of the peak F 1s as well as the peak of C 1s and O 1s were independent on the amount of C_2H_4 applied, and remained almost constant in

all cases. It is also apparent from Table 12 that the unaltered tendency of the F/C ratios varying with feed composition is well in accordance with the resulted degree of hydrophobicity of the surface.

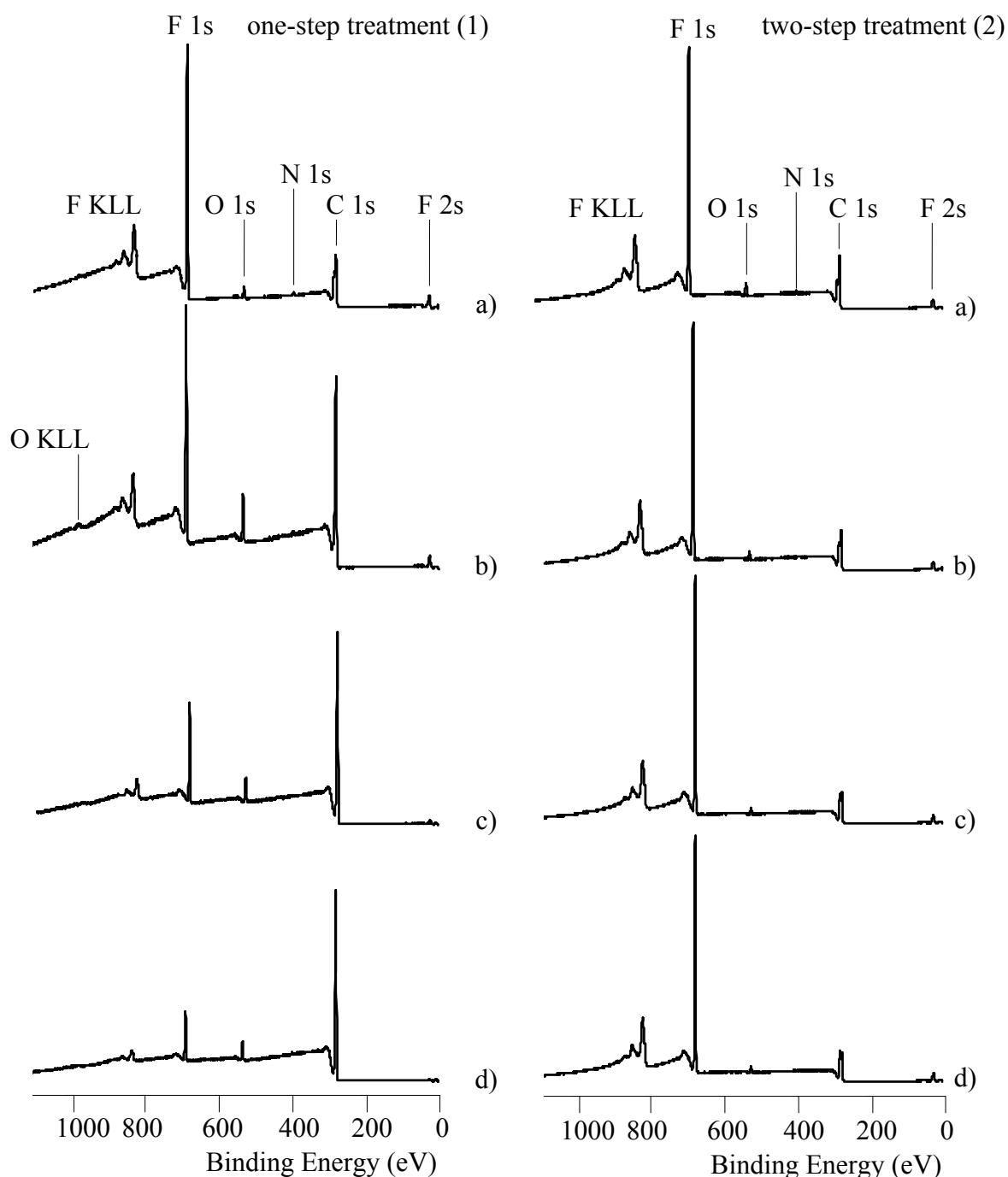

Figure 43 XPS survey spectrum of PET film surface; 1. Treated with mixtures of C_2H_4 and C_2F_6 plasma (one-step treatment), 2. Treated with C_2H_4 prior to treatment with C_2F_6 plasma (two-step treatment): (a) $C_2H_4:C_2F_6$ (1:2); (b) $C_2H_4:C_2F_6$ (1:1); (c) $C_2H_4:C_2F_6$ (2:1); (d) $C_2H_4:C_2F_6$ (3:1).

The results after a separate treatment with C_2H_4 and C_2F_6 plasma in comparison to the results received from a treatment with the mixture of the same gases could be explained with the effect of C_2H_4 , i.e., hydrogen atoms in the plasma. Hydrogen has the ability to intercept the F atoms¹⁰³, thus the presence of such fluorine scavenging agents in the feed as a mixing compound could reduce the F atom concentration through the formation of unreactive and thermodynamically stable species such as HF^{33} (bond energy is 135 kcal/mol, F–F is 37 kcal/mol). Reduction in the number of F atoms led to a corresponding decrease in contact angles. In a two-step treatment, on the other hand, the intercepting role of hydrogen is avoided. In this case, a plasma layer of polyethylene is first incorporated on the surface, followed by a graft polymerization with fluorocarbon plasma leading to an increase of chemically inert surface containing almost same fluorine content on the surface.

Table 12 Relative atomic compositions determined by XPS and contact angles of the surfaces treated in two stages with different gas flow rates of C_2H_4 and C_2F_6 gases.

Monomer composition	Relative atomic concentration (%)			Contact angle (°)	
	O/C	F/O	F/C	PET film	PET fabric
$C_2H_4: C_2F_6$					
1:2	0.04	11.34	0.56	109.2	140.3
1:1	0.03	19.14	0.63	108.1	139.3
2:1	0.03	22.22	0.69	107.7	141.4
3:1	0.02	25.49	0.67	110.1	140.2

4.3.6 FTIR(ATR)-measurements

Fibers and fabrics are the most difficult materials to handle via optical spectroscopy. Multiple reflections are necessary to be employed because the nature of these materials is such that the contact area is small¹⁷⁷. Objects having a smooth surface are quite amenable to make a good contact to the surface of the internal reflection plate and to be studied by means of infrared technology. On account of this, in lieu of a fabric sample a commercial polyester film was IR-spectroscopically analyzed to interpret the surface chemistry introduced by plasma treatment. Figure 44 shows the spectra of an untreated and pure fluorocarbon-treated PET-film surface, wherein no perceptible difference between them was observed. When the deposited layer of polymer is thick (several micrometers), the substrate does not produce an interfering spectrum causing no problem in detecting the layer. It was realized, however, that in case of a very thin layer of pure C_2F_6 plasma which is not detectable by ellipsometric measurements (only few nanometers) and even if an ideal contact could be made to the ATR, it was just not possible to

distinguish the surface spectrum from that of bulk from their relative contrast. Such drawback of these measurements can be exclusively attributable to the greater depth of penetration of the infrared rays into the material exceeding the polymer layer formed on the surface.

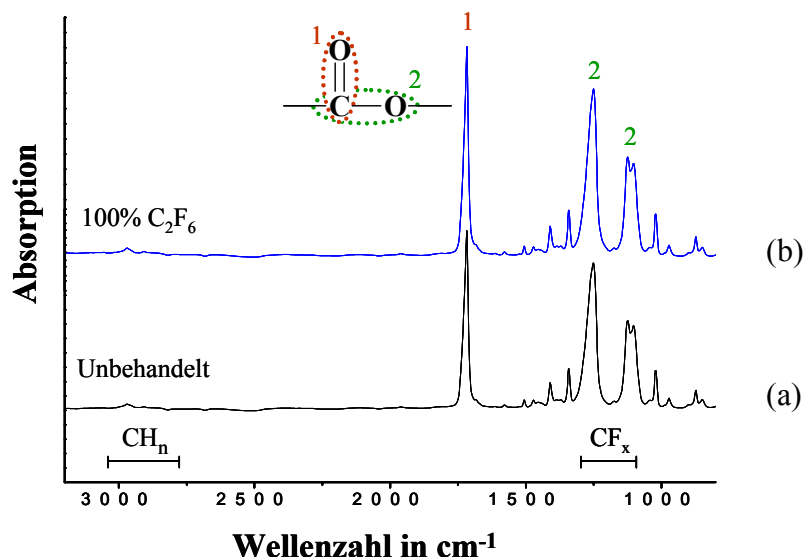

Figure 44 FTIR (ATR)- spectra of untreated PET-film (a) and modification with pure fluorocarbon plasma (b).

A layer up to 100 nm can be considered thin¹⁷⁸ and the layer formed by applied plasma system, as stated above, was too thin to be detected, probably only a few nanometres. On the contrary, the depth of penetration of the used rays is more or less 500 nm. In Figure 44 the problem is evidenced: the interested area of C – F vibration between 800 and 1600 cm^{-1} is absolutely superimposed by the absorption bands of PET-film.

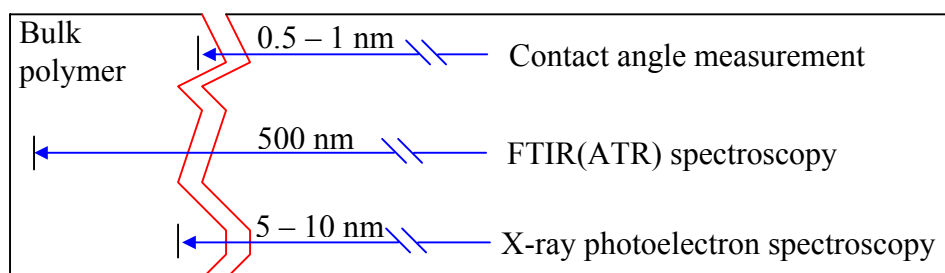

Figure 45 Analysis depth of the typical spectroscopic and physical methods⁶⁹.

4.3.7 Thickness of plasma polymers

The name "ellipsometry" stems from the fact that the most general state of polarization is elliptic¹⁷⁹. Ellipsometry measures the change in polarization, as well as the intensity, upon reflection from an electrode¹⁸⁰. Linearly polarized light, when reflected from a sample surface, will change its state to elliptically polarized. The most common application of ellipsometry is the analysis of very thin films. In Table 13 the thicknesses of polymer deposits as a function of feed gas and feed composition have been plotted.

Table 13 Thickness of polymer deposits depending on the monomer gas and variations in the amount of H₂ in a C₂F₆ feed (treatment time 120s).

Feed gas	Feed composition	Thickness of layer (nm)
CF ₄	100%	Not detectable deposit
C ₂ F ₆	100%	Not detectable deposit
H ₂ : C ₂ F ₆	1:2	10.0 ± 0.2
H ₂ : C ₂ F ₆	1:1	69.8 ± 0.2
H ₂ : C ₂ F ₆	2:1	20.4 ± 0.1
H ₂ : C ₂ F ₆	3:1	4.16 ± 0.1

It is assumed that the characteristic plasma particles are responsible for the different degree of deposition of polymers. As the literature goes⁹⁴, fluorocarbons with F/C's of 3 or greater are not likely to be polymer-forming. From the data arranged in the Table 13 it is also apparent that for pure CF₄ and C₂F₆ plasmas, for which F/C is 4 and 3 respectively, the plasma deposition is too low to be detectable within the available resolution of the instrument used. It can be assumed that the formed CF_x layers are below 2 nm thickness. As stated earlier, CF₄ plasmas are characterized by a high concentration of F atoms and relatively low concentration of CF_x radical species, whereas C₂F₆ plasmas are characterized by high concentration of CF_x and low number of F atoms. Apart from the high F/C ratio, the low CF_x/F ratio in a CF₄ plasma also disfavors the plasma deposition process. For C₂F₆ plasma, the lack of polymer formation as a thick layer is ascribed to competitive ablation and polymerization (CAP)¹⁸¹. Although C₂F₆ plasma have a fairly high CF_x/F ratio, there are still sufficient number of F atoms to inhibit the traditional plasma polymerization through the CAP mechanism.

Next to pure fluorocarbons, which is then apparent is the thickness of the polymer layer developed by addition of H₂ species to the C₂F₆ plasma wherein the mixing of these two monomers at an equal fraction, i.e., 1:1 led to a significant rise in the depositions. Upon further addition of H₂, the deposition of polymer was reduced again.

The addition of a small amount of H₂ to a C₂F₆ feed, resulting in considerable amount of formed plasma polymers, was supposed to be capable of supplying the resulting plasmas with a much higher density of CF_x species¹⁸², because in the plasmas, the following reaction can take place:

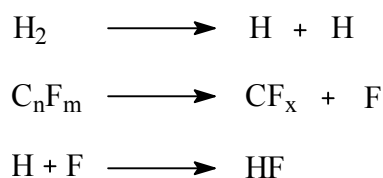
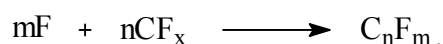

Table 13 shows further that increasing amount of H₂ reduced the extent of deposition of plasma polymers. This result suggests that there might exist a twofold effect of hydrogen atoms in the plasmas. As mentioned above, hydrogen, on one hand, can capture F atoms and reduces recombination process,



thus it increases CF_x density and raises the deposition of plasma polymers. Hydrogen, on the other hand, is able to react with CF_x species and deplete CF_x species, forming unreactive HF and thus declining plasma polymer deposition. If fluorocarbon dominates in the feed, the former effect of H is considered to play a leading role in the plasma polymer deposition, whereas at a H₂-rich fluorocarbon feed, the latter is supposed to mainly govern the formation of plasma polymers¹⁰³.

4.3.8 Surface topography

The morphological studies of the untreated and treated fabric samples were carried out using REM and showed the distinctive features of the surfaces differing from each other primarily with respect to their evenness in appearance. The image of the original fabric containing sizing agent (Figure 46) was recognized clearly by the inhomogeneity of the surface and the contact points of the filaments caused due to the film formation of the applied sizing materials. The unevenness of the surface and the sticking of the filaments impaired the hand-feel and the air permeability of the fabric. The decrease in handle property is attributable to the harshness of the film that is characteristics to almost all sizing materials. The lowering in the air permeability of the fabric as a consequence of sizing was rigorous, however, unlike typical coated fabric it was still breathable. It signifies that the sizing compounds did not form a continuous film on the surface which was also clear from the REM pictures showing that the filaments were connected with each other only in certain points.

After removal of the protective films, the smooth appearance and the soft handle of the fabric were regained. The REM micrographs showed a homogeneous and an even surface of the desized fabric, which was indicative of the complete and efficient removal of the sizing agents.

In case of the fluorocarbon finishing, the sticking of the filaments was hardly visible. All the filaments were lying free. But the overall surface appeared to be coarse-grained or spotted, which was probably due to the inhomogeneous and localized deposition of the finishing components. This unevenness contributed to surface roughness impairing the hand-feel of the bulk fabric to some extent.

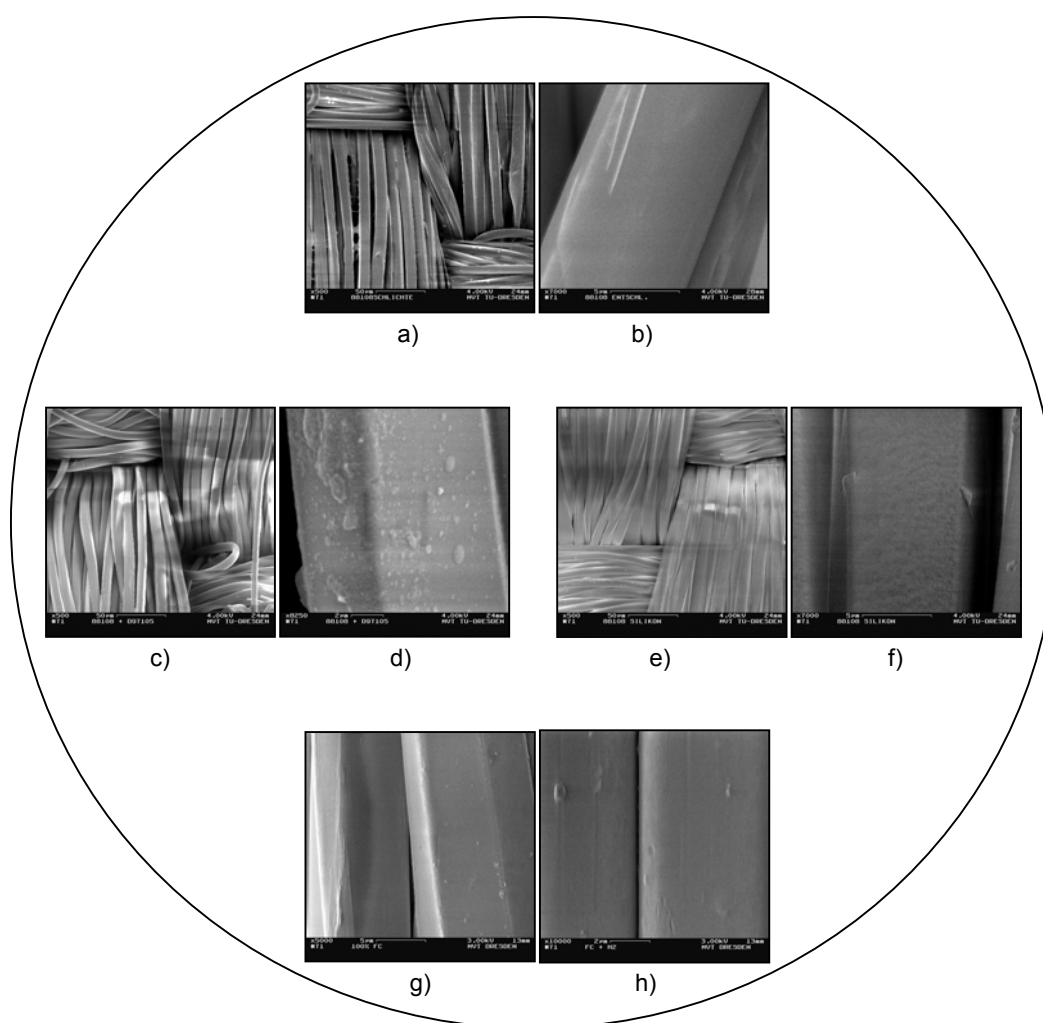

Figure 46 REM micrograph of the fabric surface: a) sized fabric, b) desized fabric, c) + d) fluorocarbon finished, e) + f) silicone finished, g) 100% C_2F_6 plasma treated, h) $H_2 + C_2F_6$ (4:1) plasma treated.

For the silicone finished samples also no contact points of the filaments were seen. In contrast to fluorocarbon treatment, the modified surface were very smooth and no inhomogeneity was

to recognize. This type of coating on superficial level¹⁷³ provides a compact and even surface morphology ensuring a pleasant grasp of the fabric material.

Compared to what was observed for wet-finished samples, REM analysis of plasma treated fabric showed no significant alternation of surface morphologies compared to the desized material. Closer scrutiny of the surface revealed that its structural geometry in consequence of plasma treatments either using pure fluorocarbon or its mixture with hydrogen got changed only to a very small extent or not at all, resembling the surface of untreated fabric.

Though C_2F_6 can etch the surface¹⁸³ causing roughness on micrometer scale¹⁰³, the change was too small to be detected by REM photograph. In this case, an alternative electron microscopy, e.g., the atomic force microscopy (AFM) can be used to detect any roughness developed by modification. However, in our studies using REM, an even appearance of the treated surfaces was observed leading to draw conclusion that the modification of PET-fabric by C_2F_6 plasma did not cause any REM-detectable change in surface topography.

4.4 Evaluation of Barrier Performance

Reusable woven fabrics had been used universally as aseptic barriers since the turn of the century. The most popular and commonly used material was referred to generically as muslin (i.e., a loosely woven, all cotton, type 140 thread count fabric)¹⁸⁴. Recently, considerable attention has been paid to the barrier properties of textiles designed for clothing as a protection against blood borne pathogens, since the health care workers are frequent in contact with patients in operating room and they face the risk of occupational transmission.

Several methods are available for the evaluations of barrier materials in terms of their ability to prevent the transmission of blood borne etiologic agents. Most of them are based on the penetration of test liquids through the fabric as a function of time coupled with a certain amount of gas pressure. Following this trend, an effort has been made to evaluate the barrier effects by constructing a small-sized instrument (see experimental part), which is composed of two portions: an upper part and an under part. To conduct an experiment, the sample with a diameter of 28 mm was placed in-between fastened with two silicone rings. The upper portion of the device (50 mm in length) was filled with test liquids and the penetration of the fluid through the sample was observed after a certain period of time. This method was, however, found to be ineffective due to the following reasons:

- apart from the uneven distribution of the pore size and structure, any unusual pin hole present in the fabric sample caused by mechanical destruction led to an imperfect evaluation of the barrier effect since all the liquids were found to penetrate predominantly through the defective place or bigger pore available.

- due to rough surface topography of the fabric an absolute sealing of the opening between the sample and the gaskets was not possible. After a certain time the test liquid ran first at the edge and then slowly soaked the entire sample.

Since the method was not successful, the investigations were accomplished in another way using an exsiccator, where no extra force has been exerted. An exsiccator is a hermetic, usually evacuable glass container, which depending on the art of application, contains on its bottom hygroscopic substances like concentrated sulphuric acid, calcium chloride, silica gel etc. in order to dry chemical compounds. Having a totally opposite objective, water was used for the present study instead of any hygroscopic substance. Theoretically, the air present in the exsiccator should take up the moisture from water, so that the entire environment in the exsiccator does not remain dry. Provided the atmosphere in the exsiccator was saturated, the problem regarding the tendency of evaporation of the droplets kept in open air was avoided, which led to the possibility to make precise evaluation of the quantity of the liquid absorbed by the fabric samples.

For every experiment, five droplets of liquid of each 100 μl volume were deposited on the sample of 85 mm diameter, which was mounted on a circular plastic frame. Extra color was mixed with the test liquids (synthetic blood and protein solution) to carry out the colorimetric evaluation.

For quantitative information of the penetration of the test liquids through the fabric samples as a measure of absorbed dyestuffs a colorimeter was used. A colorimeter is an instrument commonly used in textile industries for color measurement based on optical comparison with standard colors. Measuring the absorbance of a color at a particular frequency of visual light, the dyestuffs penetrated through the fabric sample could be analyzed qualitatively and the concentration could be quantified.

4.4.1 Absorption of synthetic blood

In order to get insight into the interaction of treated surfaces with a polar liquid other than water, first of all an artificial blood was used. The artificial blood used had a surface energy of 50 mN/m. In comparison, the humane blood has a surface energy of approx. 56 mN/m according to the literature¹³³.

In case of the desized sample the droplets of synthetic blood were absorbed outright and spread over the whole surface owing to its extreme hydrophilic character. Since the technique of colorimeter was designed to document only a small area of sample, it was therefore, not possible to measure the entire amount of dyestuffs absorbed. However, the measurement was carried out only in a certain region of the sample, nevertheless a high absorption was observed (Figure 47).

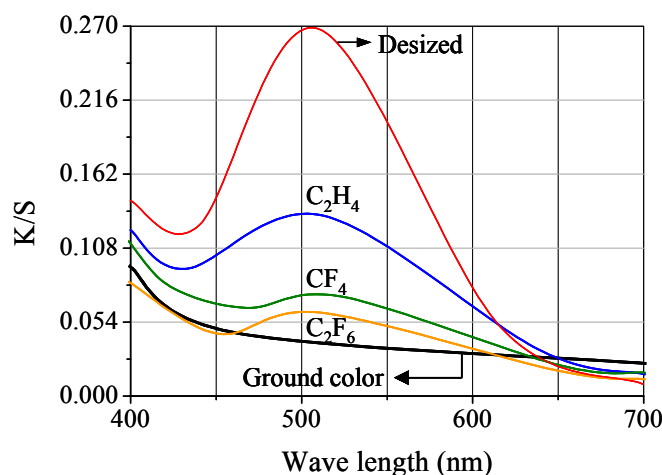

Figure 47 Absorption of synthetic blood after 2 hours measured in form of K/S-value as a function of wave length.

Next to the desized one, the absorption was most pronounced for the C₂H₄ plasma-treated sample being higher than those modified with CF₄ and C₂F₆ plasmas. This result corresponded well to the comparative higher surface energy of the surface treated with the former species. The C₂F₆ plasma modified surface appeared to be superior in resistance to absorption than the CF₄ treated one. Whilst after 1 hour duration of experiment already a reasonable amount of liquid for the CF₄ treated surface was measured, the C₂F₆ plasma-treated sample could withstand well showing no absorbance at all. Although a certain amount of absorption after 2 hours has been documented in this case, quantitatively it was however, still lower than the absorption by CF₄ treated sample measured after 1 hour.

Table 14 Quantitative absorption of synthetic blood in variously modified surfaces.

Sample	Relative Absorption	
	<i>After 1 hr.</i>	<i>After 2 hrs.</i>
Desized	> 0.27*	> 0.27*
C ₂ H ₄	0.046	0.093
CF ₄	0.024	0.040
C ₂ F ₆	0	0.020
C ₂ H ₄ + C ₂ F ₆	0	0
D-97105 (FC)	0	0
D-86071 (FC)	0	0

* Total absorption of liquid droplet.

In contrast to pure plasma treatments, modification of the fabric with a combination of C₂H₄ and C₂F₆ plasma as well as with wet-finishing method using fluorocarbon compounds were completely impervious to artificial blood. After an experimental period of 2 hours, neither any absorption nor any trace of artificial blood on the fabric surface was detected.

4.4.2 Absorption of protein solution

The absorption of blood proteins, which often possesses rather flexible structures, to the hydrophobic surfaces has been investigated using BSA (bovine serum albumin) as a model of protein. Proteins are a heterogeneous class of biomolecules with widely varying physiochemical characteristics; a general observation regarding their absorption behavior to hydrophobic modified fabric surfaces has been made.

Since the colorimetric measurements was based on the red color of the synthetic blood, the same dyestuff was additionally mixed with the protein solution. Like synthetic blood the

fabric sample free from sizing materials showed again a complete absorption of protein solution. In an analogous manner, an instant absorption and wide spreading of the droplets took place. The most striking particularity was the zero uptake of this fluid by all treated surfaces irrespective of the method of modification and type of modification agents used. The droplets completely prevented from penetration through the fabric and did not leave any stain on the surface after 2 hours experimental period.

This extreme hostile behavior of the modified surfaces against the protein solution might be associated with the complex structural compositions of the protein¹⁸⁵. The amino acids that

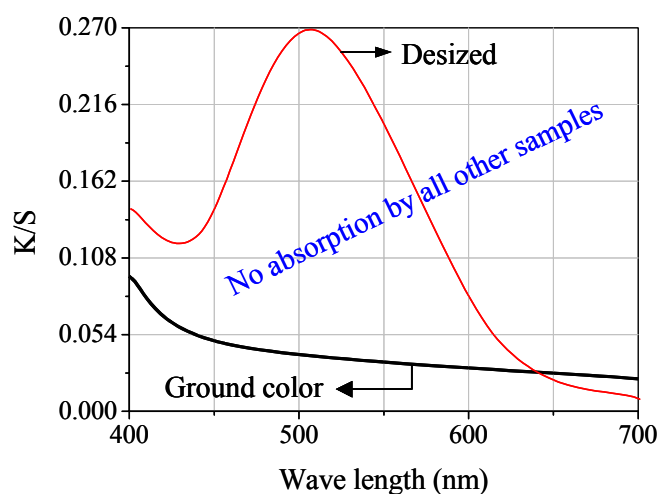

Figure 48 Protein absorption of desized fabric after 2 hours experimental time.

comprise proteins span a wide range of chemical functions, and a particular protein is likely to contain each of the 20 major amino acids somewhere within it¹⁸⁶. Therefore, a folded protein is likely to have different regions that are hydrophilic or hydrophobic in nature¹⁸⁷. The hydrophilic domains in the protein are on all accounts repelled from the hydrophobic surfaces but the total repulsion of the solution indicated that hydrophobic domains also could not undergo any interaction with the fabric material. This inability of interaction of the hydrophobic moieties might be due to the fact that either the BSA used was a protein where the hydrophilic interactions were the dominating force rather than the hydrophobic ones giving a net hydrophilic character or the modified surfaces were featured with surface energy that was too low to interact with them.

Apart from the possible hydrophobic interactions, the absorption of proteins is the net result of various types of interactions¹⁸⁸, which depend on the nature of protein and of the substrate, as well as the surrounding aqueous solution. Several driving forces determine the overall protein uptake process, including redistribution of charged groups in the interfacial film, dehydration of the protein and substrate surface, structural rearrangements in the protein molecules¹⁸⁹, and above all, the relative size of the protein and the material pores etc.¹⁸⁷

Regarding the role of substrate characteristics, other than surface chemistry¹⁹⁰ surface topography¹⁹¹ has also shown to affect protein absorption and cell adhesion.

Table 15 Relative absorption of protein solution in different hydrophobic surfaces.

Sample	Relative Absorption	
	<i>After 1 hr.</i>	<i>After 2 hrs.</i>
Desized	> 0.27*	> 0.27*
C ₂ H ₄	0	0
CF ₄	0	0
C ₂ F ₆	0	0
C ₂ H ₄ + C ₂ F ₆	0	0
D-97105 (FC)	0	0
D-86071 (FC)	0	0

* Total absorption of liquid droplet.

Above all, it was measured that the used protein solution had a surface energy of 69.9 mN/m. Since the wettability of a surface by a liquid is substantially decreased with the increased surface energy of the liquid, this higher surface energy of protein solution compared to artificial blood (50 mN/m) probably was the most crucial factor for the zero penetration of this fluid through the all treated surfaces.

4.4.3 Absorption of human blood

Blood is the fluid of life, health and growth. It is constantly flowing through our bodies and may carry undesirable pathogens^{192,193} that can be transfused-transmitted to others while coming in contact. On contrary, proteins are only a part of blood¹⁹⁶ and artificial blood is a man-made model. Both of them, however, may not be perfect representative for a genuine human blood that is more complex in composition and behavior. Therefore, the expulsion of a real blood from the hydrophobic surfaces has been investigated to get a final picture of the performance of the modified fabrics. Unlike synthetic blood and protein solution, it was not only the desized sample but also the C₂H₄ plasma-treated sample that showed no resistance to the absorption of human blood. A thorough and instantaneous spreading of the droplet on the surface did occur in both cases. Analogous to synthetic blood, the quantitative uptake of real blood by CF₄ plasma-modified surface was also higher than the absorption by the sample treated with C₂F₆ plasma.

When treated with human blood, the results obtained from the samples treated with mixture of $C_2H_4 + C_2F_6$ plasma in one-step technique and a fluorocarbon compound, D-97105, were

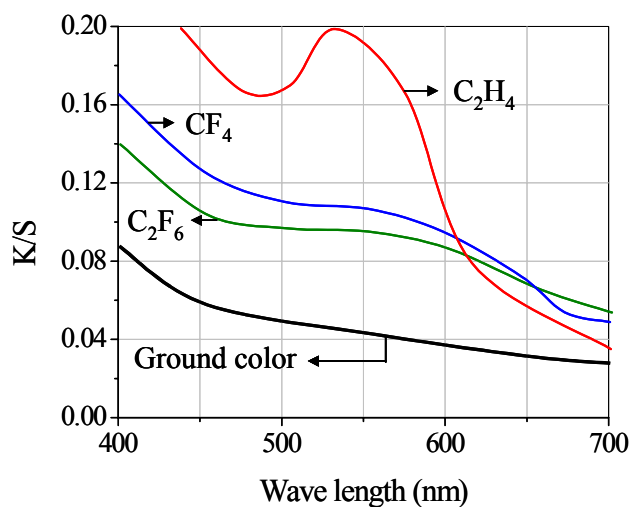

Figure 49 Difference in absorption of human blood after 2 hours exposure shown as K/S-value depending on various wave lengths.

visibly distinctive from the results upon exposure to other liquids, not in respect of their quantitative uptake but by the ability of retaining virgin surface spruceness. Whereas the droplets of synthetic blood did not leave any speck on the surfaces, in case of real blood, the top side of the fabric sample got spotted, which is attributable to the coagulation tendency, i.e., the thickening or congealing into solid clots of human blood^{194,195} when placed outside the body. Nonetheless, there was no detectable or measurable penetration of liquids through the fabric.

Table 16 Amount of absorption of real blood varying with discriminative hydrophobic treatments.

Sample	Relative Absorption	
	After 1 hr.	After 2 hrs.
Desized	> 0.20*	> 0.20*
C_2H_4	> 0.20*	> 0.20*
CF_4	0.041	0.061
C_2F_6	0.021	0.050
$C_2H_4 + C_2F_6$ ¹	0	0
D-97105 (FC) ¹	0	0
D-86071 (FC)	0	0

* Total absorption of liquid droplet. ¹Colored speck on the top side of the fabric.

Of overwhelming significance was the tremendous inert behavior of the fabric modified with one type of fluorocarbon product, namely D-86071, where the surface remained spotlessly clean after 2 hours experimental time. It is here noteworthy that by treating the material with such type of finishing agents by far the best hydrophobic character considering both contact angle and sliding angle have been achieved.

5. SUMMARY

Barrier textiles are receptive to innovative new dimensions in quality as well as in quantity to challenge the ever-increasing threatening hazards in and around the clinical environments. The chief concern of this work has been to strengthen the existing course of development by providing reusable and reliable means to protect the patients and the associated health professionals, those working, in particular, in surgical room, from cross-transformations of different bacterial and viral diseases. In the context of this work, this goal was to be realized in form of a hydrophobic barrier introduced by water-repellent entities to the fabric surface, thus, keeping the polar regions away from any oncoming polar liquids such as body fluids that are believed to be the common carriers for imminent pathogens.

To overcome the inherent drawbacks of surgical gown from classical fibers of both natural and synthetic origins, polyester micro filament fabric was used to substitute them. By using such micro fine fibers, down to 0.62 dtex per filament, the elementary problem of longevity, tear and tensile strength, larger pore structure etc. has been, in principle, solved. Over and above, the additional demand for the absence of lint, cleanability, breathability, ability to be sterilized has also been fulfilled to a large extent. However, the structural barrier by compact and even fabric geometry is still needed more investigations, which will be optimized by the partner project.

Two major pathways have been chosen to render the surface hydrophobic:

- Wet-chemical treatment
 - Fluorocarbon
 - Silicone
- Plasma modification
 - Tetrafluoromethane (CF₄)
 - Hexafluoroethane (C₂F₆)
 with or without H₂ / C₂H₄

To introduce the hydrophobic barrier function to the fabric different commercial fluorocarbon and silicone products have been applied on the pre-treated (desized) polyester micro filament fabric in varied quantities. The performance of an individual chemical was highly dependent on its applied concentration. Taking into full account the decisive parameters like impervious to liquid water, permeation to air, higher contact angle at lower concentration the following three chemicals have been chosen as the best-performing repellent agents:

- Fluorocarbon: $\left\{ \begin{array}{l} \text{D - 86071} \\ \text{D - 97105} \end{array} \right.$
- Silicone: P - SISW

The maximum efficiency of a specific chemical was not realized as long as the favorable applying conditions were not ensured. However, after a statistical experimental procedure and evaluation of the outcomes considering both wetting behavior and air permeability, the following application formulations were found to be best effective:

pH-value	$\left\{ \begin{array}{l} \text{D - 86071 (3.7 - 4.0)} \\ \text{D - 97105 (3.3 - 4.0)} \\ \text{P - SISW (4.5 - 4.8)} \end{array} \right.$	Adjusted with $\text{CH}_3\text{COOH} = 1 \text{ g/l}$
Pick-up %		60%
Drying temperature and time		100°C / 90s
Curing temperature and time		160°C / 120s

A range of physical and chemical parameters have been found exerting significant influence on the extent of modification of the material, wherein first of all, the role of wetting agent deserves annotation. Both, the water-repellency and the air permeability were found to improve by using the wetting agent up to a certain concentration. Any overdosing thereof, i.e., in excess of 3 g/l, caused undesirable decrease both in contact angle as well as in breathability of the fabric.

In case of fluorocarbon products, an almost linear relationship has been established between the amount of fluorine content in the chemical and the wetting behavior of the material showing that higher amount of fluorocarbon moieties leads to an enhancement of surface hydrophobicity. A further vital aspect of fluorochemicals was the organization and orientation of the fluorinated segments that was found to be highly depended on subsequent heat treatment after washing. Regardless of the origin of the products, a substantial loss of water-repellency was observed in all cases upon washing, presumably because of rotational movement of fluorine chain from outer surface into the bulk phase of the polymer being repelled by the hydrophilic environment during washing. This effect was, however, only a transitional phenomenon and the water-repellency was found to rise again partially or wholly depending on the amount of heat applied.

The physical parameter like ironing of the fabric, commonly encountered in practice, caused some diminishing effects on the wetting behavior of the fabric, which could be explained with the “smoothing” of the fabric surface due to the mechanical action of this process in addition to temperature.

In an endeavor to intensify the hydrophobic character of PET- surface, an alkali treatment even at high concentration (250 g/l) and coupled with high temperature (60°C) was applied. However, no significant roughening of the surface and thus, also no increase in water-

repellency was obtained. By this treatment, however, a pleasant grasp of the fabric endowed with excellent drapability and comfort characteristics has been achieved.

Plasma enhanced surface fluorination using saturated fluorine compounds CF_4 and C_2F_6 revealed to be a challenging alternative approach on account of its ability to retain the original bulk properties of the polymer and simultaneously conferring comparable hydrophobicity. Since ethylene (C_2H_4) is a hydrophobic agent in addition to its reducing action, an extra effort has been conducted to confer hydrophobicity treating the material with it alone, but no satisfactory level of effect was reached.

In a step forward, the material was treated with pure CF_4 plasma and the results obtained thereby indicated that the CF_4 plasmas are capable to impart significant hydrophobic character to the fabric surface. The over-all hydrophobicity as determined by contact angle measurements was not noteworthy pronounced being somewhat similar to that acquired with C_2H_4 plasma. Nonetheless, a significant difference between these two treated fabrics was in their water droplet rolling-off angles, where an explicitly lower magnitude of rolling-off angle has been observed in former cases.

On contrary, the exposure of the substrate to a pure C_2F_6 discharge resulted in higher contact angles as well as proportionately lower water droplet rolling-off angles despite having lower F/C ratios than the substrates exposed to the other plasmas. This higher water-repellency was to be explained with the large concentration of CF_3 and CF_2 groups on the surface treated with C_2F_6 plasma because of easier scission of its weaker C – C bonds.

Stepwise increased mixture of H_2 as a typical fluorine scavenging agent to a proportionally decreased amount of C_2F_6 plasma showed a gradual decrease in contact angle and a substantial increase in sliding angle values. For authentication of this negative approach experiments were conducted using C_2H_4 instead of H_2 . No discrimination of the effect has been observed, thus, in general, the hydrophobicity of PET surface decreased with an increase in the amount of H_2 or C_2H_4 gases in the fluorocarbon feed.

On the basis of theoretical supposition rooted from the dual nature of action of ethylene to get different outcomes in plasma treatment, in addition to the treatments with gas mixtures a two-step technique, i.e., treatment with C_2H_4 prior to C_2F_6 plasma, was applied that appeared to be very promising in modifying the surface characteristics. Both, the contact angles and the sliding angles remaining almost constant on a very high level with increasing amount of C_2H_4 in the feed composition.

An essentially vital concern of the work was the characterization of the treatment effect comprising both physical and chemical aspects. By washing the materials for 20 times no significant impairment of hydrophobic character has been noticed in case of fluorocarbon finishing agents, the effect reduction being less pronounced with D-86071. Most striking feature was the complete loss of hydrophobic effect washing the silicone-treated materials for 10 times. Samples modified with pure CF_4 showed least resistance to washing treatment. On

contrary, pure C_2F_6 treated surfaces experienced moderate diminishment upon washing. It was of particular importance that the durability of the modification of the surface treated with C_2H_4 followed by C_2F_6 plasma was greatly enhanced.

In breathability aspect, the plasma modification was found to be the best-suited technique with zero reduction of air permeability. The fluorocarbon treatments did not show any marked decrease in air permeability; only about 10% decrease has been recorded by D-86071, whereas the silicone-treated substrates suffered from a slightly higher reduction in air permeability.

The observation of the ageing properties pointed out that the polymer surfaces treated with CF_4 and C_2F_6 plasma were tolerably susceptible to the environments showing a little bit decrease in contact angle in the course of a week of storage at ambient conditions. In both cases, however, no further deterioration of hydrophobicity has been found to occur until 30 days. The hydrophobic character obtained for surfaces treated in other ways did not decay with time indicating higher degree of cross linking formed during the modification.

The tensile strength as a measure of mechanical properties of the fiber provided significant information regarding the effect of treatment and the role of sizing material present in the fiber. The strength of fiber was substantially decreased upon removal of the size, but was restored after a fluorocarbon finish. While the silicone chemicals led to a moderate increase in tensile strength, the treatment with plasma did not result in any alternation of the material properties, since the action of plasma modification is essentially confined to changing in surface chemistry, which undergoes no or very minor change in fundamental structure of the yarns.

The chemical characterization of the surfaces by means of XPS analysis quantitatively showed the correlation between the fluorine species present on the surface and the given hydrophobicity. It has been identified well the reason of higher contact angle for the fabric treated with the commercial fluorocarbon chemical, D - 86071 and also the lower angle for P-3, a commercially finished fabric. The reason was clearly demonstrated by showing the incorporation of more perfluoroalkyl species on the surface in former case. By one-step plasma modification, the declining tendency of contact angle with increased amount of ethylene fraction in the fluorocarbon feed was in good accordance with the respective declined F/C ratios obtained by XPS analysis. Treating the material in two-step technique, the unaltered tendency of hydrophobic nature with varying feed compositions was also well in accord with the XPS results showing almost the same fluorine content for all feed compositions in the topmost layer of the fabric.

The morphological studies conducted by REM provided distinctive features of the untreated and treated fabric samples. In the micrograph of the original fabric, the inhomogeneity of the surface and the contact points of the filaments were recognized. The complete and effective removal of this size was justified from the image of the desized sample that contained again a homogeneous and an even surface structure. In case of the fluorocarbon finishing, the

attachment of the filaments was hardly visible but the overall surface appeared to be coarse-grained or spotted, which was probably due to the irregular and localized deposition of the finishing components. On contrary, the silicone-modified surfaces were highly smooth and no inhomogeneity was identified. Compared to both fluorocarbon and silicone treatments, the structural geometry of plasma-treated surface remained almost unaffected.

Of substantial interest of the work was the verification of the acquired barrier function of the fabrics against blood borne pathogens. The barrier test as a measure of dye absorption was conducted on a specially designed apparatus using protein solution, synthetic and human blood and the efficiency were verified by colorimetric technique. The desized sample showed resistance to none of the liquids and the droplets were absorbed outright and spread over the whole surface. In case of synthetic blood, the fabric treated with C_2F_6 plasma showed superiority in resistance to absorption than the CF_4 and C_2H_4 treated sample and the absorption was more pronounced by C_2H_4 treated sample than the CF_4 treated one. Unlike synthetic blood and protein solution, it was not only the desized sample but also the C_2H_4 plasma-treated sample that showed no resistance to the absorption of human blood. Analogous to synthetic blood, the quantitative uptake of real blood by CF_4 plasma-modified surface was also higher than the absorption by the sample treated with C_2F_6 plasma. In contrast to pure plasma treatments, modification of the fabric with a combination of C_2H_4 and C_2F_6 plasma as well as with wet-finishing method using fluorocarbon compounds were completely impervious to artificial blood, whilst they showed moderate susceptibility to real blood. The most striking feature was the zero uptake of the protein solution by all treated surfaces. The droplets were completely abstained from penetration through the fabric and no stains were left on the surface even after 2 hours observation period.

To conclude, under the application particularly of a commercial fluorocarbon product, D-86071 and a two-step plasma technique comprising C_2H_4 and C_2F_6 plasmas the principal objective of this work to enhance the barrier effect of a polyester micro filament fabric by patterning an ultra hydrophobic surface has been extensively realized. At the same time, the basic requirements for a surgical gown such as the high wash stability, a very good air permeability, and the least susceptibility to absorption of body fluids have also been fulfilled to a large extent.

6. OUTLOOK

What could be done as continuation of the work includes inclusion of prospective and potential efforts, improvement of the attained outcomes and execution of some conducted experiments in detail. The possibilities are listed as below:

- Hydrophobic treatment of the raw material, i.e., prior to removal of sizing chemical to examine the effect of the presence of size on the fabric.
- Application of fluorocarbon repellents along with integrated silicone segments in the polymer chain to improve the hand-feel of the bulk.
- AFM characterization of plasma-treated PET-film surface to demonstrate any roughness developed by modification.
- XPS-analysis of the washed samples to correlate change in hydrophobicity and surface chemistry.
- Chemical explanation of the phenomenon of substantial increase in sliding angle with regard to contact angle by gradual rise of H₂ fraction in a C₂F₆ plasma feed.
- In lieu of colorimeter, UV-VIS spectroscopic evaluation of the absorbed fluids should be used for characterization of the barrier effect. This alternative approach would measure the concentration of the extracted dye and thus, enabling to calculate the total absorption of a particular liquid (e.g., by C₂H₄ plasma treated sample) irrespective of the magnitude of the measurement area.
- Application of the optimized hydrophobization methods to the ideal fabric developed by the partner project.

7. EXPERIMENTAL

7.1 Materials

Wet-chemical finishing as well as plasma treatment was performed mainly on commercial polyester micro filament fabrics. The fabric materials containing a sizing material were supplied by the company Lauffenmühle, Germany, for which the following information were available¹⁹⁷:

Article name	S 88108
Construction	100% PES-micro filament
Composition	Warp: 100% PES; Weft: 100 % PES
Weave	Plain (1/1)
Weight	130 g/m ²
Texture (compactness)	0.866
No. of filament	Warp: 68 Weft: 269
Filament count in dtex	Warp: 1.47 Weft: 0.62
Filament diameter in μm	Warp: 11.60 Weft: 7.54

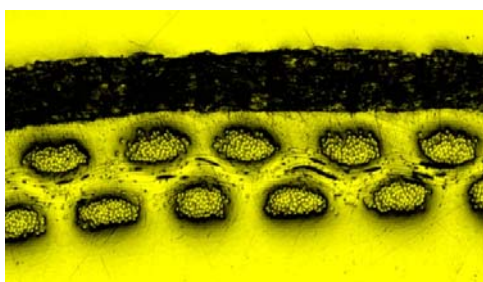

Warp filament

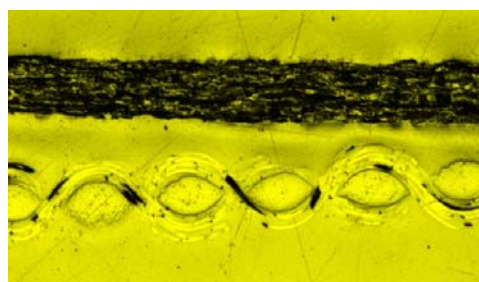

Weft filament

Figure 50 Cross sectional view of warp and weft yarns of polyester micro filament fabric used as the commercial standard.

For some experiments, another two commercial polyester micro filament fabrics have been used. These are namely P-3 and P-13. The technical parameters available for these fabrics are listed in Table 17.

Table 17 Characteristic data of the fabrics P-3 and P-13.

Fabric	Weave	Texture (compactness)	No. of filament		Filament count in dtex		Filament diameter in μm	
			Warp	Weft	Warp	Weft	Warp	Weft
P-3	Plain (1/1)	1.012	88	288	1.46	0.61	11.56	7.46
P-13	Plain (1/1)	0.989	338	160	0.32	1.26	trilobal	10.74

Both of these fabrics were commercially finished with fluorocarbon chemicals. From structural viewpoint, the fabric P-3 resembles to the standard fabric of Lauffenmühle (S 88108). This is why most of the experiments based on wet-chemical finishing were also done on it parallel to the standard fabric to compare the results. P-13 exhibits a different cross sectional shape of filaments in the warp direction of the fabric. This was, therefore, used to examine the influence of its special cross sectional design on the hydrophobicity.

As an exception, films of poly (ethylene terephthalate) were substituted for fabric to carry out the FTIR and XPS analysis for better understanding of the surfaces. The PET films of 0.1 mm thickness from Goodfellow GmbH were used as received.

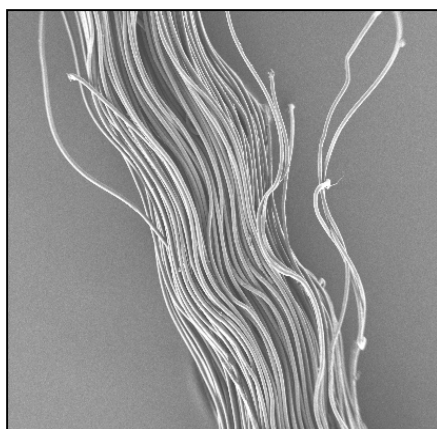
**Figure 51** A single polyester yarn composed of numerous filaments.

7.2 Pre-Treatment

Identification of sizing agent:

To ensure the effective removal of the sizing materials from the fabric it is a strong prerequisite to identify the agents present. To ascertain the art of size the following two methods are commonly used in practice:

1. Detection direct on the fabric surface.
2. Detection in aqueous extract.

While the detection of sizing agents in aqueous extract is tedious, detection direct on the fabric surface by means of various commercial reagents provides instantaneous information of the material present; hence, it is widely practiced in industry. Due to rapidity in action the identification procedure was conducted according to this method by utilizing a cationic dyestuff (Astrazonrot F3BL) that is capable of dyeing the sizing materials only, provided that the anionic group containing sizing chemicals such as polyester, polyacrylate and polyacrylate-NH₄ salt are present on the fabric surface.

Using the basic dye as a primary reagent, the presence of either type of these agents was first detected. For discrimination, a second variety of reagent (Mixed indicator 5) was thereafter used that confirmed the presence of the size, polyacrylate-NH₄-salt in the case of used fabric producing blue color with orange edging that was not given by others.

Table 18 Detection of sizing materials direct on the fabric surface.

Type of size	Reagent	Coloration/criteria
Starch and its derivatives	Iodine/Potassium iodide	Blue/Violet
Polyvinyl alcohol	Iodine/Potassium iodide	Greenish blue
	Mixed indicator 5	Green
Polyvinyl acetate	Basic dyestuff	According to dyestuff used
	Mixed indicator 5	Green
Polyacrylate	Basic dyestuff	According to dyestuff used
	Mixed indicator 5	Brown
Polyacrylate-NH ₄ salt	Basic dyestuff	According to dyestuff used
	Mixed indicator 5	Blue with orange border
Polyester	Basic dyestuff	According to dyestuff used
	Mixed indicator 5	Blue with red border

Removal of sizing materials:

The identified polyacrylate-NH₄-salts could not be removed simply by washing with water as it could be done in case of water soluble sizing materials like starch, polyvinyl alcohol etc. That is why they were removed by treating the fabric material in two steps with the recipes given below:

1st-step:

Tissocyl CSB = 3 g/l (non-ionic wetting agent)
 NaOH = 2 g/l
 Temperature = 80°C
 Time = 30 min
 Liquor ratio = 1 : 60

2nd-step:

Tissocyl CSB = 1.5 g/l
 NaOH = 2 g/l
 Temperatur = 80°C
 Time = 30 min
 Liquor ratio = 1 : 60

In course of washing using these chemicals, the water insoluble functionalities (-COOCH₃ and -COOH) of the size present are turned into water-soluble products (Figure 52), which were then removed from the fabric in-depth by three consecutive intensive washing operations at a temperature near to boiling using fresh water for each cycle. The subsequent washing treatments were also necessary to remove any residual wetting agent on the surface that might adversely affect the efficiency of the next finishing operation.

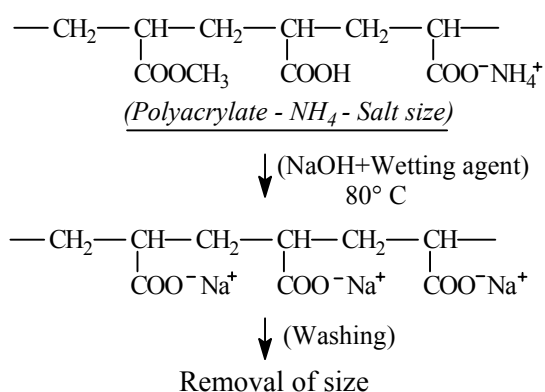

Figure 52 Chemical procedure of desizing operation.

Proof of effective desizing:

Reagent: 1.0% acetic acid solution of Bezacrylrot BL fl. 50%
or
0.5% acetic acid solution of Astrazonrot F3BL

One approx. 10 cm² large fabric sample was dipped in the test solution up to the complete wetting (approx. 5 seconds), and then the fabric sample was kept for 30 seconds on a glass plate. Subsequently, the sample was rinsed for 60s in a beaker with water (ML 1:500 to 1:1000) under agitation, taken out, dipped briefly into fresh water (approx. 2 seconds) and finally dried on a glass plate in air or in drying chamber at about 100°C.

7.3 Hydrophobic Treatment

7.3.1 Wet-finishing

7.3.1.1 Chemicals

A series of commercial varieties of fluorocarbon and silicone based products and other associated auxiliaries were used for experimental purposes. Fluorocarbon products were obtained from Rotta GmbH and the company Bayer AG supplied the silicone compounds.

Fluorocarbon compounds¹⁴³:

1. Polyacrylate based:

Dipolit-97105	Aqueous dispersion of pure fluorocarbon resin, contains no copolymer, cationic in nature.
Dipolit-470	Aqueous emulsion of fluorocarbon containing no copolymer, faintly cationic.
Dipolit-86074	Pure fluorocarbon resin, contains middle range of fluorine, acidic in nature.
Dipolit-480	Emulsion of fluorocarbon resin copolymerized with vinylidene chloride, contains fluorine in fewer quantity, non-ionic.
Dipolit-86071	Aqueous dispersion of fluorocarbon resin copolymerized with vinylidene chloride, contains fluorine in higher quantity, cationic.

2. Polyurethane based:

R-Coating 97660: Dispersion of organic pigments in fluorocarbon resin/polyurethane.

Silicone compounds¹⁹⁸:

Perlit 40159:	Polydimethylsiloxane, silicone oil emulsion with additives of an epoxy resin and an organic metal compound, cationic.
Perlit SI-SW:	Aqueous, without metallic salt emulsion of polymethylhydrogen-siloxane, contains alkyldimethyle benzylammoniumchloride, weakly cationic.

Cross linking agent¹⁴³:

Rotal 444: Aqueous dispersion of modified polyisocyanate, non-ionic.

Rotal-Fix 567: Concentrated, partially etherified melamine-formaldehyde condensation product, residual formaldehyde content below 0.5% in 75% product, alkaline in nature.

Wetting agent¹⁴³:

Rotta-Wet 495: Phosphoric acid ester, non-ionic, pH value 5.5 ± 1 by 5 g/l.

7.3.1.2 Methodology

The wet-finishing to increase the barrier effect of the fabric took place under the application of finishing agents by means of well-known padding technique (Figure 53). The typical method of application consists simply of padding the dried goods after a short immersion (2 min) in a bath containing finishing chemicals at room temperature, followed by squeezing and drying at 100°C. As a final step, condensation of the material was accomplished in a drying chamber at elevated temperatures.

To ensure a better penetration and even distribution of the hydrophobic agents, the padding liquor was vigorously agitated after the incorporation of all chemicals until they were finely dispersed in the solution. A mangle expression of 60 – 70% was carried out on an average, by using rubber rollers of medium hardness at 25 – 35 kg/cm² pressure. The fabric specimen was passed through the rollers at least for 6 times to reach the desired pick-up% calculated according to the following equation:

$$\text{Pick-up\%} = \frac{\text{Fabric wt. after impregnation} - \text{Fabric wt. in dry condition}}{\text{Fabric wt. in dry condition}} \times 100$$

Though it is preferable to use at least three rollers for a double dip and nip in order to get through penetration into the fabric, it was, however, not possible to perform it with the instrument available that consisted of a pair of rollers. This lack in nipping was minimized by repeated passage of the sample through the rollers.

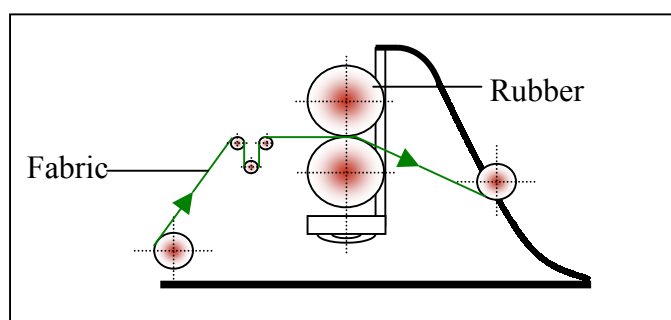

Figure 53 Fabric padding mangle.

7.3.2 Plasma modification

7.3.2.1 Equipment

Plasma treatments were carried out in a commercial plasma installation (Darius 10 H/M) made by Buck plasma electronic GmbH, Germany. The principal part of plasma instrument, the reactor, is a stainless-steel cylindrical vessel, 30 cm in length and 20 cm in diameter. Aside from this capital component, it consisted of 4 other modules or functions:

- Vacuum system
- Power supply
- Gas flow controller
- Pressure measurement system

Physical parameters:

- Frequency: 2.45 GHz (Microwave-Generator), 13.56 MHz (RF-Generator)
- Plasma power: 0 – 300 watt
- Base pressure: 0.01 mbar (1 Pa)
- Working pressure: 10 – 150 Pa
- Gas inlet: 2 gas inlets at the chamber entrance
- Gas flow: measurable in different measuring ranges, e.g., 20, 50, 100, 200 sccm

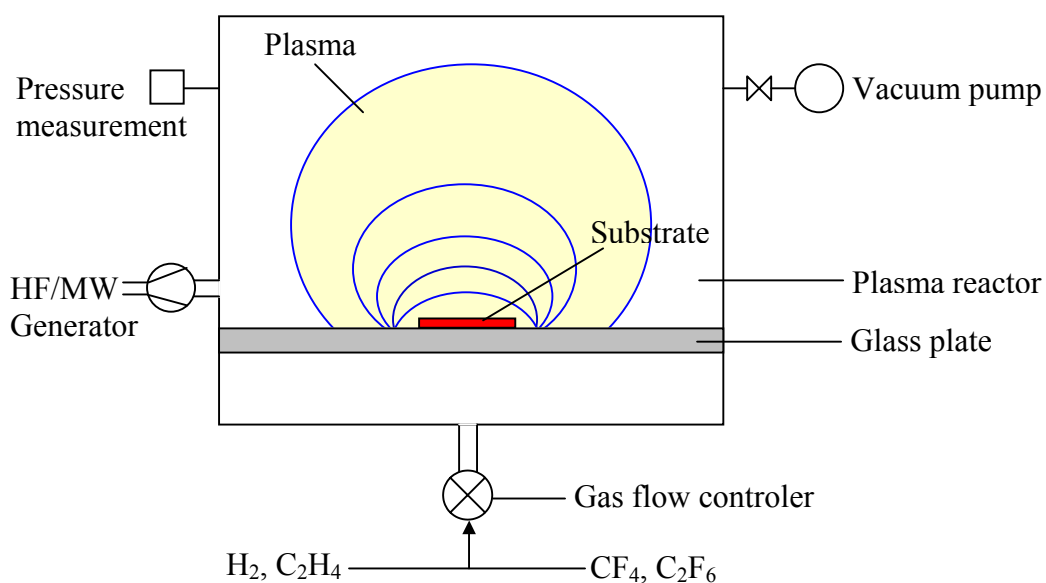

Figure 54 Block diagram of a typical plasma system.

7.3.2.2 Process gas

Poly (ethylene terephthalate) substrates were given hydrophobic treatment using the following commercially available saturated plasma gases and mixtures thereof with reducing agents such as H₂, C₂H₄ in different ratios under different power, pressure and time conditions.

Tetrafluoromethane (CF₄):

- Brand name: Tetrafluoromethane UHP (R 14)
- Supplier: Messer Griesheim GmbH
- Purity: 99.995 vol.%
- Gas flow conversion factor: 0.42

Hexafluoroethane (C₂F₆):

- Brand name: Hexafluoroethane UHP (R 116)
- Supplier: Messer Griesheim GmbH
- Purity: 99.99 vol.%
- Gas flow conversion factor: 0.24

Hydrogen (H₂):

- Supplier: Messer Griesheim GmbH
- Purity: 99.95 vol.%
- Gas flow conversion factor: 1.01

Ethylene (C₂H₄):

- Supplier: Messer Griesheim GmbH
- Purity: 99.95 vol.%
- Gas flow conversion factor: 0.60

7.3.2.3 Treatment procedure

The substrates were cut into required dimensions and placed in the center region of the reactor on a glass plate. Before treatment, the reactor is pumped down to its base pressure equal to 1 Pa using a rotary pump. Gaseous monomers, CF₄, C₂F₆, C₂H₄ and H₂, were supplied in a purity of more than 99% and used without further purification. They were fed into the plasma processor and adjusted to a desired flow rate by a mass flow meter. Fluorocarbons and

ethylene or hydrogen gases were fed to the chamber separately through 2 inlets located at the chamber entrance.

The plasma was produced with a high frequency generator at the microwave frequency of 2.45 GHz. Once the preset pressure (typical 10 – 150 Pa) was reached and remained constant, the glow was initiated and set at desired level. The glow continued for a predetermined period of time. After plasma treatment, the vacuum chamber was simply vented to atmosphere, and the treated samples were handled with due care to avoid surface contamination.

7.4 Evaluation

7.4.1 Degree of Hydrophobicity

To measure the extent of hydrophobic modification of the treated surfaces, the following two methods were applied:

Contact angle measurements:

The measurements of static contact angle were carried out on treated substrates by sessile drop method [drop shape analysis (DSA)] using a G 40 apparatus (Krüss GmbH, Germany). A micro syringe was used to dispense a 4-5 μl (approx.) droplet on the surface of the material. By setting the drop illumination extra care was taken so that no reflections are visible on the drop image. For an accurate and average measurement of the hydrophobic character the droplets were deposited on different regions of the surface. In order to define the droplet profile, a line tangent to the curve of the droplet is drawn at the point where the droplet intersects the solid surface. With the help of an illuminator and a camera, the image of the droplet was captured and the droplet was then analyzed using the image analysis program.

To determine contact angle there are four methods available: Tangent 1, Tangent 2, H/W-Method (height-width method) and Sessile Drop Fitting¹⁹⁹. The H/W method gives reliable data for contact angles less than 90 degrees. In the framework of this work, the Sessile Drop Fitting method was applied that fits the drop shape to the Young-Laplace equation and is recommended for contact angles greater than 90 degrees.

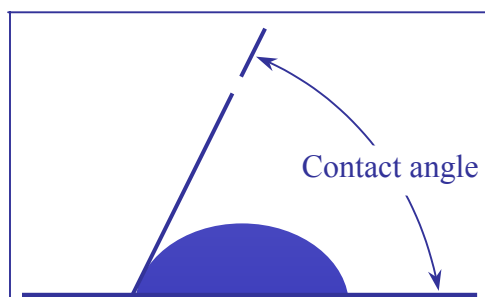

Figure 53 Contact angle on solid hydrophobic surface.

The measurement of contact angles on fabric surface is somewhat complex. A proper measurement was not possible without keeping the fabric under certain tension. Therefore, a clamping device was used for this purpose. The sample was cut into desired dimensions

(approx. 5 x 2.5 cm) and placed in-between two clamps of the device where it was stretched to some degree to get a wrinkle-free surface.

The water used for such measurements was distilled, deionized, and filtered through a Millipore-Q system. Each measurement was done few seconds after the drop was deposited to avoid evaporation. At least 5 readings on different surface locations were averaged for each sample. The typical standard variations of measurements were 1-2°.

The determination of the surface energy and its dispersive and polar components were carried out on PET-film surface instead of fabric and the calculations were done by the Owens-Wendt-Kaelble method. In addition to water, diiodomethane as an unipolar liquid was used for such measurements.

Sliding or Rolling-off angle measurements:

The angle at which the water droplets started to roll-off the surface were measured by the test schematically shown in Figure 56. While the measurements of contact angle have taken place on a horizontally placed static surface, the sliding angle was measured on a surface that was gradually inclined from its horizontal alignment until the water droplets started to slide or to roll off the fabric surface.

The speed of inclination of the surface was approx. 8 – 10 mm/s. An exact volume of droplet of 10 µl was used measured with a volume adjustable pipette. The accuracy of the technique was in the order of ± 2°.

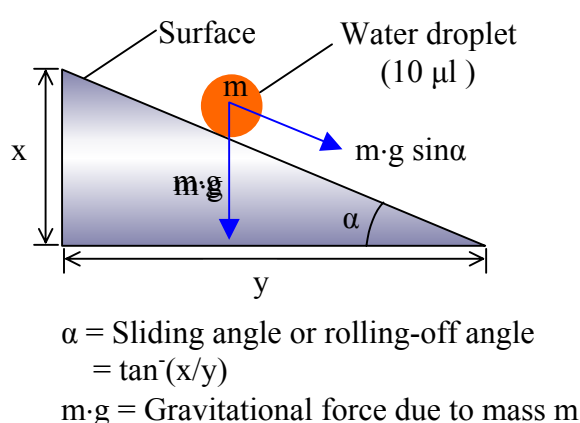

Figure 56 Scheme of sliding angle measurement.

7.4.2 Durability

The degree of stability of the treated surfaces was ascertained by subjecting the modified fabrics to a series of washing treatments (up to 20 times) on laboratory scale according to the

norm DIN 45010, followed by contact angle measurements. The samples were washed using a sample washing instrument from Mathews, Switzerland. Washing the materials according to the formulation given below was rinsed with cold water before each measurement, dried in a drying chamber at 100°C and shortly thereafter contact angle was measured conducted at an interval of 10 times washing.

Washing recipe:

CH ₂ –(CH ₂) _{16,14} – COOK	5 g/l (Detergent)
Na ₂ CO ₃	2 g/l
Liquor ratio	1 : 50
Temperature	60°C
Time	30 min

7.4.3 Air permeability

The change in air permeability of the treated fabrics was measured according to the norm EN ISO 9237 by using the air permeability-measuring instrument 21443 (Frank GmbH, Germany). Since the air permeability varied over the fabric width to a large extent (approx. 12 to 20 l/m²s), it was given not in absolute value, but in proportional decrease calculated according to the following simple equation:

$$L \% = \frac{(L_b - L_a)}{L_b} \times 100$$

where L_b and L_a denote the air permeability before and after the treatment respectively.

The mode of action of this equipment consisted of the fact that through a sample held in the clamping device the blower air is sucked under a certain adjusted vacuum. The amount of air passing through the sample per sec is to be read off from the flow meter. For adequate precision of measurements the sample was marked beforehand and exactly in the same position the air permeability of the respective material was measured before and after modification.

The measuring surface of a sample was 20 cm². Measurements were carried out at previously marked different locations of a particular sample and the calculated average value was taken as the standard. The error of the technique was ± 1 l/m²s.

7.4.4 Tensile strength

The tensile strength measurements of the untreated and treated fabric in stripe form were executed following the norm EN ISO 13934-1 by means of a Zwick Material Testing Machine, Germany.

To conduct this mechanical test the fabric sample was clamped vertically in center region between two clamps, so that their mid-line runs in the longitudinal direction through the middle of the front edge of the clamping. A 100 x 5 cm test piece of fabric was clamped with a certain amount of input tension. Clamping with initial load it was to be guaranteed that the stretch did not exceed 2%. As soon as the equipment got started, the clamps moved with the predetermined speed of 100 mm/min and the stretching was continued until rupture of the sample. For a single measurement the following results were to note down:

- Tensile strength in Newton and
- Elongation in per cent.

The investigations were done only in the warp direction of the fabric and 5 experimental values obtained from 5 separate specimens were averaged to reach an utmost accurate result of measurement.

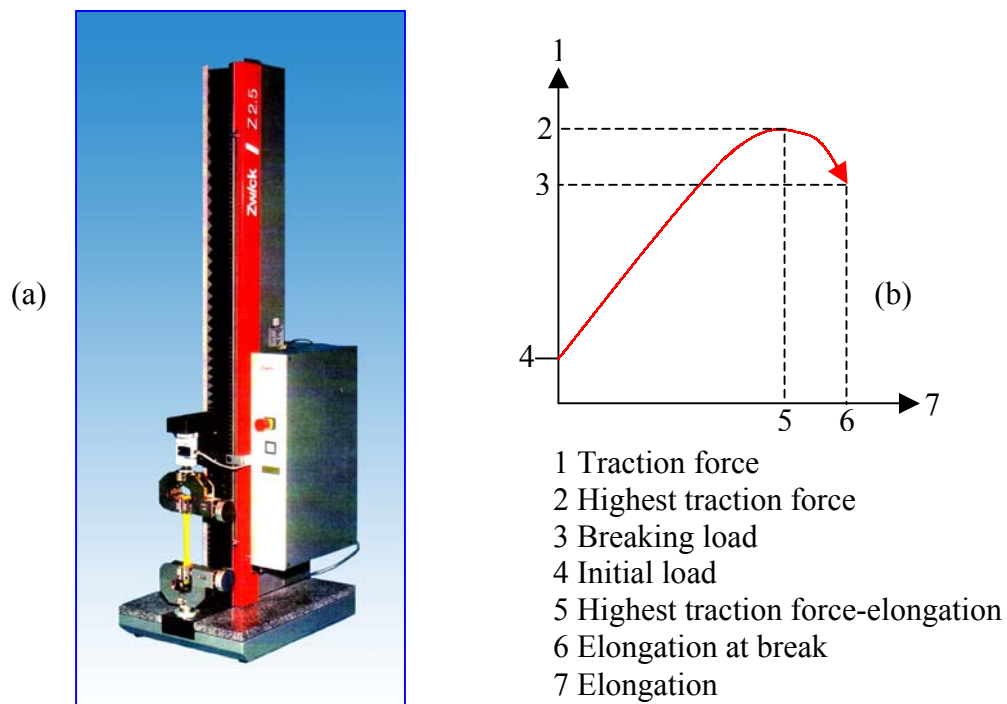

Figure 57 Equipment used for tensile strength measurement (a). Example of a stress-strain curve (b).

7.5 Surface Analysis

7.5.1 FTIR-spectroscopy

In an effort to analyze the surface of PET-film modified with plasma, Attenuated Total Reflectance (ATR) FTIR technique was used. The measurements were done in an IFS 66v (Bruker) spectrometer configured with a mercury/cadmium/tellurium (MCT) detector capable of detecting in the range of $4000 - 600 \text{ cm}^{-1}$.

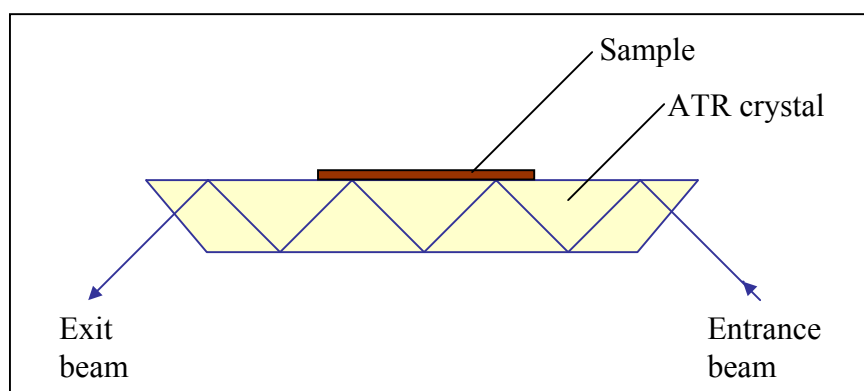

Figure 58 Multiple internal reflection ATR plate showing path of light.

The ATR unit was from the company Harrick (Twin parallel mirror reflection Attachment). A germanium ATR-crystal, 45° (i.e., the penetration depth of IR-rays depending on the wave length between 0.17 and $1.1 \mu\text{m}$) was used for the experiments. The polymer samples were analyzed at 4 cm^{-1} resolution and 200 scans per measurement. All sample collection and spectra data processing was handled using the OPUS software.

The samples were placed on both sides on the horizontal face of the internal reflectance crystal where total internal reflection occurs along the crystal-sample interface. The source of energy entering the crystal is reflected within the crystal, the number of reflections depending upon the crystal length, its thickness, and the interface angle. At each reflection, the light beam penetrates the sample a small amount, and is absorbed at the characteristic absorption frequencies. All the samples were needed to be pressed against the ATR crystal to obtain good contact.

7.5.2 X-ray photoelectron spectroscopy (XPS)

To provide keen information of the chemical nature of sample surfaces or surface near regions X-ray photoelectron spectroscopy (XPS) was used that involves the measurement of binding

energies (E_b) of electrons ejected by interactions of a molecule with a monoenergetic beam of soft x-rays.

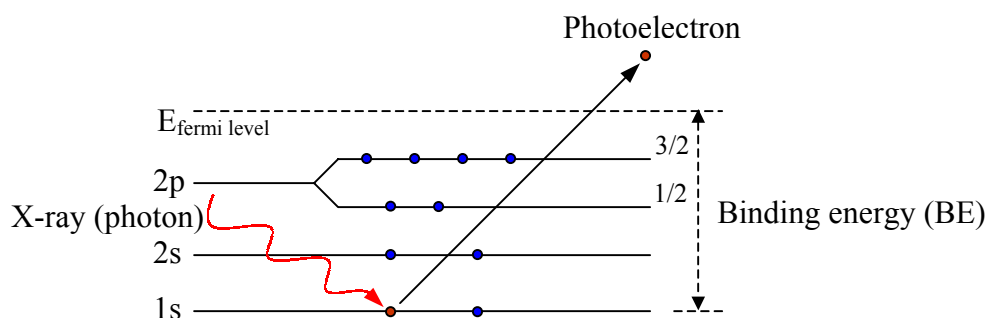

Figure 59 XPS emission process: An incoming photon causes the ejection of photoelectron.

The spectra were obtained on an Axis Ultra (Kratos Analytical, England) photoelectron spectrometer with a monochromatic Al $K_{\alpha 1,2}$ X-ray source with corresponding photon energies 1486.6 eV. The X-ray source was operated at 300 W by 20 mA.

The use of monochromatic source is especially important for polymers to minimize sample radiation damage and to provide the spectral resolution necessary to determine plasma-induced species²⁰⁰. All samples were analyzed at ambient temperature and exhibited no

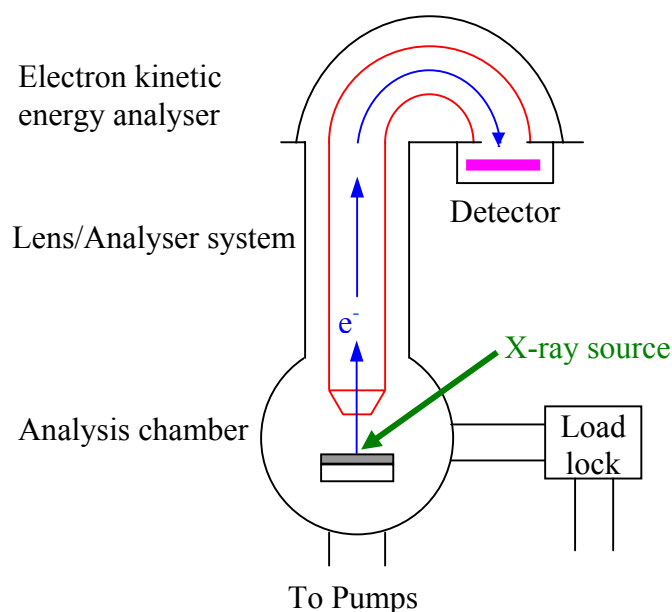

Figure 60 X-ray photoelectron spectrometer.

evidence of damage during measurements. The electron binding energy is calculated from the photon energy ($h\nu$) of incident x-rays and the kinetic energy of the emitted electron according to the following equation²⁰¹:

$$h\nu = E_b + E_{\text{kin}}$$

The binding energy reference for the C 1s peak of the unsaturated carbon of phenyl ring (-C = C-) and the F 1s signal for the CF₂ groups were set at 284.70 eV and 689.67 eV respectively²⁰². Elements were identified by survey spectra. For the survey spectra a pass energy of 160 eV was utilized, which was reduced to 20 eV for the high-resolution spectra. Peak deconvolution and quantification of the elements were accomplished using the software and the sensitivity factors supplied by the manufacturer. The random error in the quantitative analysis of elemental compositions was 7 – 8%.

7.5.3 Ellipsometry

To determine the layer thickness developed by different plasma treatments the Variable Angle Spectroscopic Ellipsometry (VASE) was utilized. It is equipped with an automated computer controlled goniometer; a horizontally mounted sample stage and 75-Watt Xenon short arc lamp. Radiation below 400 nm is filtered off by a WG 360 Schott glass filter before it reached the polarizer. After reflection from the sample and passing through the analyzer the light is dispersed onto a detector array, which permits to perform fast measurements (in some seconds) simultaneously at 44 wavelengths between 428 and 763 nm.

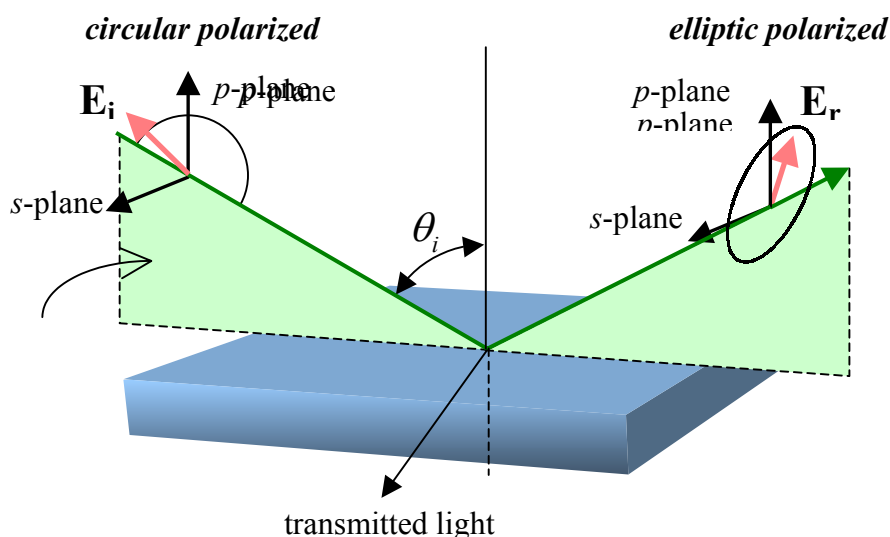

Figure 61 Basic principle of ellipsometry.

The mathematical theory for ellipsometric analysis is based on the Fresnel reflection or transmission equations for polarized light encountering boundaries in planar multilayered materials^{203,204}. These come from solutions to Maxwell's equations²⁰⁵. Ellipsometry does not

directly measure film thickness, it measures Ψ and Δ . Therefore, the ellipsometric measurement is normally expressed in terms of two ellipsometric angles, Psi (Ψ) and Delta (Δ)^{206,207}:

$$\tan(\Psi) \cdot e^{i\Delta} = p = \frac{r_p}{r_s}$$

where r_p and r_s are the complex Fresnel reflection coefficients of the sample for p- (in the plane of incidence) and s- (perpendicular to the plane of incidence) polarized light, illustrated in Figure 61. The change in amplitude and phase of the polarized light upon reflection is determined in these two components, which define the ellipticity p (a complex number).

To pinpoint the real deposited thickness of plasma polymer, in place of PET-film a silicone-wafer coated with an oxide layer of 50 nm thickness was used. A mild acetic acid cleaning was given to the surface of the samples prior to plasma treatment to remove the dust particles and other foreign materials that might cause unwanted interference in processing as well as in measurements.

The thickness was determined one day later in as-treated condition of the samples. The relative humidity during the measurements was held at approx. 40% and the ambient temperature at approx. 22°C.

7.5.4 Raster electron microscopy (REM)

REM is a combination of imaging, diffraction and spectroscopy techniques for characterization of topography, fine structure and composition of surfaces of single element²⁰⁸. High-energy electrons are incident at glancing angles to the surface and reflected electrons are used to form an REM image. The incident beam is scanned over the specimen in a series of lines and frames called a raster. The raster movement is accomplished by means of small coils of wire carrying the controlling current (the scan coils). A schematic drawing of an electron microscope is shown in Figure 62.

In performing a measurement, first the electrons are sped up and pushed into the wanted direction to hit the object in a particular point. This happens in the tube. When the ray of primary electrons hits a point of the object's surface, secondary electrons are thrown out by the object's surface, which are caught by a detector and worked into a picture. The number of electrons thrown out depends on the angle of incidence of the primary electrons, in other words of the angle of the surface. The secondary electrons are "sucked off" by an anode

(detector), which is charged positively and therefore attracts electrons (negative charge). The brightness of this point on the screen depends on the number of secondary electrons.

In this work, a commercial installation, LEO DSM 982 GEMINI microscope was utilized for morphological studies of the fabric samples. It is a high resolution and low acceleration voltage REM equipped with the GEMINI field emission column. This can be used with acceleration voltages from 0.2 kV to 30 kV. The GEMINI column provides typical resolutions of 4nm at 1kV, up to 1nm at 30kV. The main chamber and the load lock are set up for 6" wafers. The maximal reasonable magnification of an object is about 200 000-fold²⁰⁹.

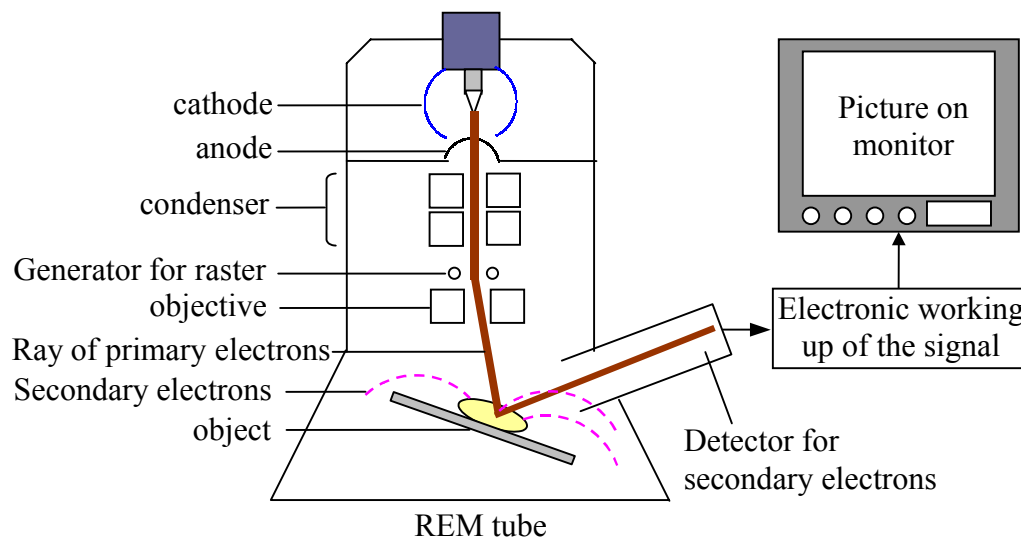

Figure 62 Schematic diagram of a raster electron microscope showing reflection of secondary electrons.

To conduct a measurement the samples were cut into tiny pieces of around 12 mm diameters. For required electrical conductivity the samples were covered with a thin layer of gold by sputtering. Five samples were placed at a time in the measuring unit and the randomly selected micrographs were documented in different enlargements.

7.6 Evaluation of Barrier Effect

7.6.1 Test liquids

In order to appraise the efficiency of barrier activities of the modified surfaces against absorption or penetration the following polar liquids were used:

1. Water – Distilled, deionized, and filtered through a Millipore-Q system, surface energy = 72 mN/m (approx.)
2. Protein solution – Bovine Serum Albumin (5%), dissolved in a solution containing the following components:

Phosphate buffered saline (PBS)	0.01 M
Potassium chloride	0.0027 M
Sodium chloride	0.137 M
Red dyestuff	0.01%
<hr/>	
Surface energy	69.9 mN/m
pH	7.4

3. Synthetic blood – The standard chemical composition of artificial blood was as follows:

Carboxymethyl cellulose (CMC):	2.0 g
Tween 20:	10 ml
Potassium dihydrogen phosphate:	1.2 g
Disodium hydrogenphosphate-dihydrate:	5.4 g
Amaranth red dyestuff:	1.0 g
Sodium chloride:	2.4 g
Distilled water	X ml
<hr/>	
Total	1000 ml

To reach the surface energy of the solution near to the theoretical value of the real blood, extra water was added. The used synthetic blood had a surface energy of 50 mN/m.

4. Humane blood- the clinically tested human blood was stored in a refrigerator and was used within 3 days of procurement.

7.6.2 Absorption test

Using the liquids described above two efforts have been made to carry out the absorption tests:

- a) Test in glass tube
- b) Test in exsiccator

a) Test in glass tube

An instrument, as shown in Figure 63, was constructed to evaluate the barrier characteristics of fabric sample. The design of this apparatus was driven by the goal of a minimum intrusive instrument to provide quantitative information of the surfaces conducting the experiments under certain gas pressure on a specimen with a diameter of 28 mm.

The device is composed of two portions: an upper part and an under part; the sample was placed in-between fastened with two silicone rings. Through a coupling located atop the upper portion the required amount of gas pressure on the sample could be applied. Excess pressure developed inside the glass tube could be withdrawn through an outlet positioned underneath the bottom tube.

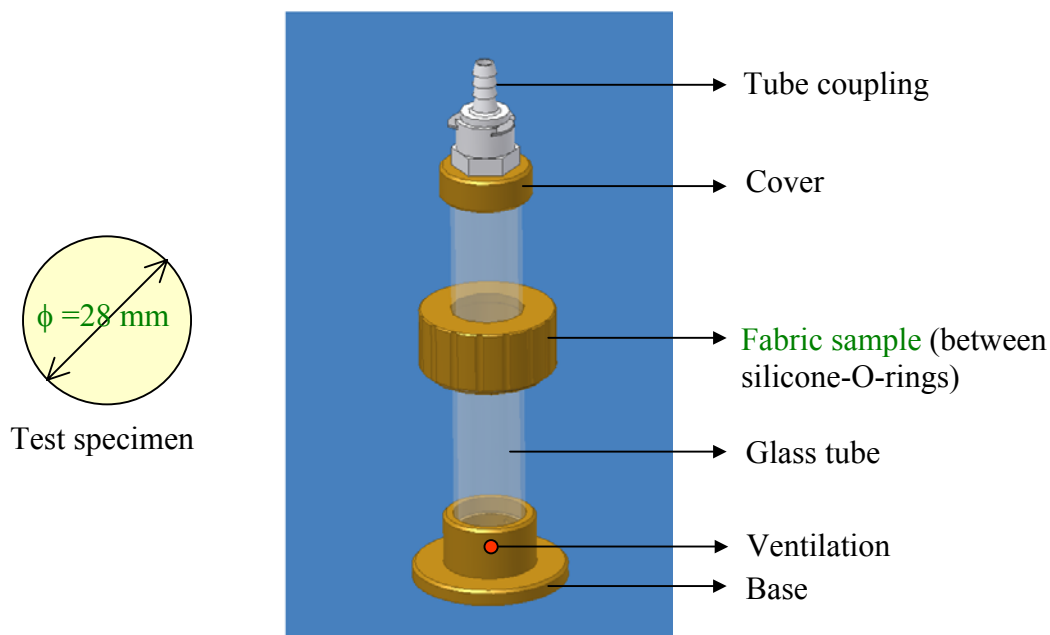

Figure 63 Equipment for testing barrier effect of fabric.

b) Test in exsiccator

A glass-made exsiccator was utilized as an alternative method to determine the barrier effect, wherein normal water was kept at the bottom. Closing the dehydrator with a lid, it was

allowed to stay overnight to reach a saturated atmosphere through exchange of moisture between water and surroundings inside the glass vessel. The sample of 85 mm diameter was mounted on a circular plastic frame tightly affixed with another frame, whereupon five droplets of liquids of each 100 μl volume were deposited with a micro syringe. The surface-liquid interaction was evaluated measuring the extent of dyestuff absorption contained in the fluid. The first observation was carried out after one hour of droplets deposition. Another five droplets were placed on new positions and laid for two hours.

The residual liquids remaining on the surface were absorbed aback as far as practicable with tissue paper. In case of a complete spread up of liquids only one droplet was used to avoid additional absorption of liquids.



Exsiccator

Droplets of liquid

Figure 64 Experimental set-up for the test of barrier effect using an exsiccator.

7.6.3 Colorimetric evaluation

The amount of absorbed dyes by the fabric samples was analyzed by means of data color system, i.e., colorimeter, which measures the dyestuff absorption as K/S-value as a function of wavelength. The K/S-value is directly proportional to the strength of absorbed color and is calculated according to the Kubelka-Munk equation^{210,211}:

$$\frac{K}{S} = \frac{(1 - \beta)^2}{\beta}$$

Where β is the degree of remission = $R/100$. R , the internal reflectance, obtained from software calculation is expressed as a per cent value. For simplification, the fractional value of β , deduced from R , was put on the above equation to compute the K/S value.

Since the results of colorimetric measurements is the summation of the ground color of the material and the color absorbed thereby, the inherent substrate color was deducted form the total measured value to get the real figure of absorption.

$$(K/S)_{\text{measured}} = (K/S)_{\text{absorbed}} + (K/S)_{\text{fiber}}$$

$$(K/S)_{\text{absorbed}} = (K/S)_{\text{measured}} - (K/S)_{\text{fiber}}$$

The principle of colorimetric measurements was simple in operation. As customary, the instrument was initially calibrated using a black and a white object. Upon completion of modulation, the actual measurements were conducted placing the spotted area of the sample on the measuring point of the device. By operation, a selected wavelength of electromagnetic radiation is passed through the dyed region and the amount of the electromagnetic radiation that the dye absorbs (does not allow to pass) or transmits (does allow to pass) is converted into an electrical signal that is registered on the transmittance and absorbance scales. The

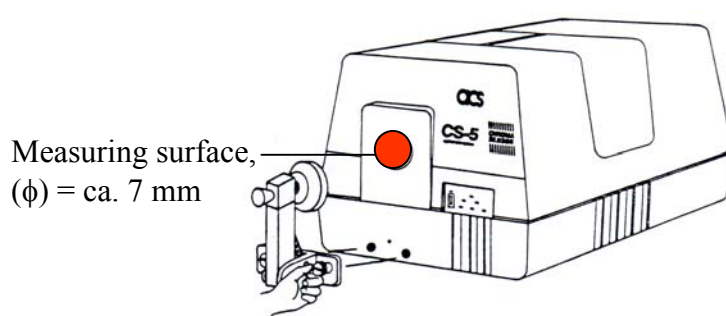

Figure 65 Block diagram of colorimeter.

absorbance of a given color is proportional to its concentration i.e., a more concentrated solution gives a higher absorbance reading. The light spectrum of visible wave lengths (400 – 700 nm), ranging from violet to red, is used to analyze the absorption.

The dimension of a measuring point of the sample was approx. 7 mm in diameter. All the measurements were carried out on the bottom side of the sample, i.e., on the opposite side of the deposition of droplets. This enabled to determine only the quantity of dyes that passed through. After inserting the sample and before recording measurements, i.e., during the whole time of operation the lid of the sample holder remained closed to shut out stray light. The reported values correspond to the average of five measurements performed on five different droplet positions on the sample. Typical shifts of $\pm 3\%$ with respect to this average value were observed.

In case of a total absorption of liquid, the measurements were done in various zones of the sample in a random fashion. The values obtained were averaged, which is, however, not representing the actual amount of absorption in this case.

8. LIST OF SYMBOLS AND ABBREVIATIONS

AFM	Atomic force microscopy
approx.	approximately
ATR	Attenuated total reflectance
BE	Binding energy
BSA	Bovine serum albumin
°C	temperature in degrees celsius
°C/S	temperature versus time in second
cm	centimeter
D	Depolit
DMT	Dimethyl terephthalate
DSA	Drop shape analysis
dtex	decitex
EG	Ethylene glycol
e.g.	for example (Latin;exempli gratia)
eV	electron volt
FC	Fluorocarbon
F/C	Fluorine to carbon ratio
F/O	Fluorine to oxygen ratio
FTIR	Fourier transform infrared spectroscopy
g/l	gram per liter
h	hour
hrs.	hours
Hz	Hertz
i.e.	that is (Latin: id est)
IR	Infra rot
K	Kelvin
KHz	Kilohertz
Kg	Kilogram
kV	kilovolt
l	liter

mA	milliampere
mbar	millibar
MHz	Megahertz
ml	milliliter
ML	Material to liquor ratio
mm	millimeter
mm/s	millimeter per second
Mn	Number average molecular weight
mN/m	millinewton per meter
N	Newton
N/C	Nitrogen to carbon ratio
nm	nanometer
O/C	Oxygen to carbon ratio
OP	Operation
OR	Operation room
Pa	Pascal
PET	Polyethylene terephthalate
PTA	Pure terephthalic acid
REM	Raster electron microscopy
RF	Radio frequency
s	second
sccm	standard cubic centimeter per minute
S.T.	Surface tension
UHP	Ultra high purity
UV	Ultraviolet
vol.	volume
W	Watt
wt.	weight
XPS	X-ray photoelectron spectroscopy
θ	contact angle
γ_c	critical surface tension
($^\circ$)	degree
γ_{lv}	interfacial tension liquid/vapor
γ_{sv}	interfacial tension solid/vapor
γ_{sl}	interfacial tension solid/liquid
μm	micrometer
α	sliding angle

9. REFERENCES

1. J. S.-Ledakowicz, B. G.-Grabowska, J. Lewartowska, 7th Dresden Textile Conference, Dresden, 16 – 17 June, **2004**
2. R. Cox, Medtex03, 8-9 July, Bolton, UK, **2003**
3. G. Sun, Medtex03, 8-9 July, Bolton, UK, **2003**
4. R. D. Anandjiwala, Medtex03, 8-9 July, Bolton, UK, **2003**
5. M. Heide, Klettenwirk-Praxis, 4, **1998**, 15
6. A. R. Horrocks, S. C. Anand, Handbook of Technical Textiles, Woodhead Publ. Ltd., England, **2000**
7. H. Mucha, D. Höfer, S. Abfalg, M. Swerev, Melliand Textilberichte, 4, **2002**, 238
8. M. Pociute, B. Lehmann, A. Vitkanskas, Material Science, 9/4, **2003**, 410
9. M. Bossard, Textilveredlung, 1/2, **1999**, 16
10. F. W. Billmeyer, Textbook of Polymer Science, Wiley-Interscience, NY, **1962**
11. H. Kittel, Lehrbuch der Lacke und Beschichtungen, vol. 1, part I, Verlag W. A. Colomb., Stuttgart-Berlin, **1971**
12. J. I. Kroschwitz, High Performance Polymers and Composites, John Wiley & Sons, NY, **1991**
13. E. S. Wilks, Industrial Polymers Handbook, vol. 1, Wiley-VCH, Weinheim, **2001**
14. H. Eberle, H. Hermeling, M. Hornberger, D. Menzer, W. Ring, Clothing Technology, vol. 4, Europa-Lehrmittel, Vollmer, **1995**
15. H. J. Koslowski, Chemie Faser Lexikon, vol. 11, Deutscher Fachverlag, **1997**
16. M. Lewin, E. M. Pearce, Handbook of Fiber Chemistry, vol. 2, Marcel Dekker Inc., NY, **1998**
17. M. Harun, Diplomarbeit, Maschinenbau (AuTK), TU Dresden, **2002**
18. H. F. Mark (ed.), Encyclopedia of Polymer Science and Engineering, vol. 12, Wiley-Interscience, NY, **1988**
19. V. K. Kothari, Progress in Textiles: Science & Technology, vol. 2, IAFL Publ., India, **2000**
20. W. Bobeth, Textile Faserstoffe, Springer-Verlag, Berlin, **1993**
21. R. W. Moncriff, Man-Made Fibres, Heywood & Company Ltd., London, **1963**

22. S. M. Burkinshaw, *Chemical Principles of Synthetic Fibre Dyeing*, Blackie Academic & Professional, London, **1995**
23. J. Baumann, G. Jerg, *Text. Chem. Col.*, 22, **1990**, 12
24. M. Sayem, *Textiles & Clothing*, December, **2000**, 4
25. <http://encyclozine.com/Wikipedia>
26. E. B. Moller, 6th Nordic Symposium, Trondheim, Norway, June 17-19, **2002**
27. A. Böhringer, *Textilveredlung*, 11/12, **2002**, 14
28. H.-J. Buschmann, H. Fik, E. Schollmeyer, *Textilveredlung*, 7/8, **2000**, 16
29. H. F. Mark, S. M. Atlas, E. Cernia, *Man-Made Fibers*, vol. 3, John Wiley & Sons, NY, **1968**
30. C. Tuente, *Melliand Textilberichte*, 5, **2000**, 355
31. R. Grottenmüller, *Melliand Textilberichte*, 10, **1998**, 743
32. N. Islam, U. Lappan, B. Voit, *Melliand Textilberichte*, 7-8, **2003**, 638
33. L. Zhang, W. S. Chin, W. Huang, J. Q. Wang, *Surf. Interface Anal.*, 28, **1999**, 16
34. S. Sigurdsson, R. Shishoo, *J. App. Polym. Sci.*, 8, **1997**, 1591
35. M. Miwa, A. Nakajima, A. Fujishima, K. Hashimoto, T. Watanabe, *Langmuir*, 16, **2000**, 5754
36. M. Kubo, *Surface*, 33, **1995**, 185
37. J. L. Moilliet, *Waterproofing and Water-Repellency*, Elsevier Publ. Co., Netherlands, **1963**
38. H. Nakamichi, in *Polymeric Materials Encyclopedia*, J. C. Salamone (ed.), vol. 2, CRC Press, NY, **1996**
39. S. Smith, P. O. Sherman, 3M Company, US 3 529 995, **1970**
40. A. Ullah, *Cleanfax Magazine*, Special issue, **1997**, 1
41. G. Duschek, *Melliand Textilberichte*, 7-8, **2001**, 604
42. R. H.-Stephan, *Textilveredlung*, 7/8, **1997**, 32
43. D. Lämmermann, *Melliand Textilberichte*, 9, **1993**, 883
44. H. B. Goldstein, *Text. Res. J.* 31, **1961**, 377
45. H. Chrobaczek, F. Dirschal, S. Lüdemann, *Melliand Textilberichte*, 3, **1999**, 175
46. C. Tomasino, *Chemistry & Technology of Fabric Preparation & Finishing*, Raleigh, North Carolina, **1992**
47. E. G. Shafrin, W. A. Zisman, *J. Phys. Chem.*, 64, **1960**, 519
48. F. Dufor, C. Jordan, P. Viallier, *JSDC*, 114, **1998**, 258
49. J. M. Corpat, A. Dessaint, *Melliand Textilberichte*, 78/9, **1997**, 135
50. E. Kissa, *Repellent Finishes*, in *Handbook of Fiber Science and Technology*, vol. 2, Wiley Interscience, NY, **1984**
51. A. Ullah, *Cleanfax Magazine*, April, **2001**, 1

52. C. E. Ophardt, Virtual Chembook, Elmhurst College, Chicago, USA, **2003**
53. K. Ramaszeder, Textilveredlung, 11/12, **1995**, 30
54. K. Nakao, The Textile Machinery Society of Japan, Chapter IV, section I, **1973**
55. R. Wagner, H. Lange, A. Hesse, H. Höcker, Melliand Textilberichte, 6, **2002**, 469
56. Ullmann's Encyclopedia of Industrial Chemistry, Wiley-VCH Verlag GmbH, **2002**
57. A. J. Sabia, Textile Chemist and Colorist, 26/8, **1994**, 13
58. R. Li, L. Ye, Y. W. Mai, Composites, 28A, **1997**, 73
59. J. D. Callen, Fundamentals of Plasma Physics, Madison, USA, **2003**
60. H. Thomas, B. Denda, M. Hedler, et al., Melliand Textilberichte, 5, **1998**, 350
61. X. J. Dai, L. Kviz, An Odyssey in Fibres and Space, Textile Institute 81st World Conference, Melbourne, Australia, April, **2001**
62. X. M.-Qui, L. B.-Xiang, J. of Dong Hua University (eng. ed.) 19, **2002**, 68
63. G. Allan, A. Fotheringham, P. Weedall, 1st Autex Conference, vol.1, Technitex, **2001**
64. M. Nitschke, J. Meichsner, J. Appl. Sci., 65, **1997**, 381
65. E. M. Liston, L. Martino, M. R. Wertheimer, in Plasma Surface Modification of Polymers, M. Strobel, C. S. Lyons, K. L. Mittal (ed.), VSP Utrecht, Netherlands, **1994**
66. H. K. Route, Encyclopedia of Textile Finishing, vol. 3, Laumann-Verlag, Dülmen, **2001**
67. G. L. Rogoff, IEEE Transactions on Plasma Science, 19, **1991**, 989
68. P. Krüger, 2. Wörlitzer Workshop, Dessau, October, **2000**
69. M. Strobel, C. S. Lyons, K. L. Mittal, Plasma Surface Modification of Polymers, VSP Utrecht, Netherlands, **1994**
70. U. Vorher, Techtexil-Symposiums, Frankfurt/M, **1997**
71. H. Fuchs, R. Bochmann, H.-U. Poll, S. Schreiter, Textilveredlung, 3/4, **1999**, 23
72. A. Bradley, J. D. Fales, Chem. Technol., 4, **1971**, 232
73. T. Bahners, E. Schollmeyer, Textil Praxis International, June, **1994**, 422
74. J. Schulz, Coating, 8, **1999**, 309
75. J. Schulz, Coating, 4, **2001**, 124
76. U. Hatmann, Coating, 8, **2001**, 270
77. G. M. Milles, Coating, 3, **1999**, 106
78. J. Friedrich, Adhäsion, Kleben & Dichten, 1-2, **1997**, 28
79. H. K. Route, Melliand Textilberichte, 6, **1994**, 513
80. G. Bonizzoni, E. Vassallo, Vacuum, 64, **2002**, 327
81. H. Dorst, Plasmachemie, Akademie-Verlag, Berlin, **1978**
82. G. Stipan, Coating, 12, **2000**, 468
83. K.-D. Vissing, G. Ellinghorst, C. M.-Reich, Textilveredlung, 9/10, **2001**, 22
84. T. Wakida, S. Tokino, S. Niu, H. Kawamura, Textile Res. J., 63/8, **1993**, 433
85. R. Taege, S. Rödel, FLOCK, 29/112, **2003**, 20

86. M. Strobel, S. Corn, C. S. Lyons, G. A. Korba, *J. Polym. Sci.: Polym. Chem.*, **23**, **1985**, 1125
87. H. Shinohara, M. Iwasaki, S. Tsujimura, et al., *J. Polym. Sci.*, **10**, **1972**, 2129
88. D. T. Clark, W. J. Feast, W. K. R. Mugrave, I. Ritchie, *J. Polym. Sci.: Polym. Chem.*, **13**, **1975**, 857
89. M. Strobel, D. A. Thomas, C. S. Lyons, *J. Polym. Sci.: Polym. Chem.*, **25**, **1987**, 343
90. M. Strobel, S. Corn, C. S. Lyons, G. A. Korba, *J. Polym. Sci.: Polym. Chem.*, **25**, **1987**, 1295
91. M. Strobel, C. S. Lyons, P. A. Thomas, *J. Polym. Sci.: Appl. Polym. Symp.*, **42**, **1988**, 73
92. G. A. Corbin, R. E. Cohen, R. F. Baddour, *Macromolecules*, **18**, **1985**, 98
93. D. T. Clark, W. J. Feast, W. K. R. Mugrave, I. Ritchie, *J. Polym. Sci.: Polym. Chem.*, **13**, **1975**, 857
94. YU. Iriyama, H. Yasuda, *J. Polym. Sci.: Polym. Chem.*, **30**, **1992**, 1731
95. T. Yagi, A. E. Pavalth, A. G. Pittman, *J. Appl. Polym. Sci.*, **27**, **1982**, 4019
96. M. Anand, R. E. Cohen, R. F. Baddour, *Polymer*, **22**, **1981**, 361
97. J. W. Coburn, E. Kay, *IBM J. Res. Dev.*, **23**, **1979**, 33
98. Y. Haque, B. D. Ratner, *J. Polym. Sci.: Polym. Phys.*, **26**, **1988**, 1237
99. E. Kay, A. Dilks, *J. Vac. Sci. Technol.*, **18**, **1981**, 1
100. Y. Haque, B. D. Ratner, *J. Polym. Sci.: Polym. Phys.*, **26**, **1988**, 1237
101. F. Denes, Z. Q. Hua, R. A. Young, J. L. Shohet, *Plasma and Polymers*, **2/1**, **1997**, 1
102. R. d'Agostino, F. Cramarossa, V. Colaprico, R. d'Ettola, *J. Appl. Phys.*, **54/3**, **1983**, 1284
103. H. Z. Wang, M. W. Rembold, J. Q. Wang, *J. Appl. Polym. Sci.*, **49**, **1993**, 701
104. N. K. Adam, in *Waterproofing and Water-repellency*, J. L. Moilliet (ed.), Elsevier Publ. Co., **1963**
105. International Organization for Standardization Catalogue, ISO9865: **1991**
106. International Organization for Standardization Catalogue, ISO9865: **1992**
107. H. Herlinger, B. Küster, W. Volz, *Melliand Textilberichte* **67(11)**, **1986**, 330
108. E. Kissa, *Textile Research Journal*, **66(10)**, **1996**, 660
109. C. J. Oss, R. J. Good, M. K. Chaudhury; *Adv. Colloid Interface Sci.*, **28**, **1987**, 35
110. Anonym, *Internatinal Glass Review*, **2**, **2001**, 82
111. I. Grosse, *Melliand Textilberichte*, **6**, **1999**, 532
112. L. Feng, S. Li, H. Li, et al., *Angew. Chem.* **114(7)**, **2002**, 1269
113. A. W. Adamson, *Physical Chemistry of Surfaces*, Interscience Publ., NY, **1963**, 51
114. Y. Iriyama, T. Yasuda, D. L. Cho, H. Yasuda, *J. Appl. Polym. Sci.*, **39**, **1990**, 249

115. A. J. Rigby, S. C. Anand, Handbook of Technical Textiles, Woodhead Publ. Ltd., England, **2000**
116. M. E. Huth, AORN Journal, 32, **1980**, 1030
117. W. C. Beck, Amer. J. Surgery, 105, **1963**, 560
118. N. L. Belkin, AORN Journal, 55, **1992**, 1521
119. H. Rudolph, Unfallchirurgie 3, **1993**, 186
120. K. K. Leonas, Amer. J. of Infection Control, 26, **1998**, 495
121. A. Glawe, R. Reuscher, Textilveredlung, 7/8, **2002**, 14
122. D. Aibibu, B. Lehmann, P. Offermann, AUTEX Research Journal, 3/4, **2003**, 186
123. F. H. Kayser, K. A. Bienz, J. Eckert, J. Lindenmann, Medizinische Mikrobiologie, Georg Thiema Verlag, Stuttgart, **1992**
124. Anonym, Securimed, Product information, DMC, Ecully, France, **1997**
125. L. P. Brown, Internationales Textilbulletin, Vliesstoffe, 4, **1995**, 26
126. H. Mergeryan, Conference Report, Symposium on Textile Finishing, Mannheim, January, **1997**
127. J. Alvarez, B. L.-Symonowicz, AUTEX Research Journal, 3, **2003**, 72
128. SB. Warner, P. Desai, National Textile Center Annual Report, Sep. 30, **1993**, 121
129. S. Brzezinski, M. Ornat, G. Malinowska, Textilveredlung, 3/4, **1999**, 22
130. H. Mucha, D. Höfer, S. Abfal, M. Swerev, Melliand Textilberichte, 1, **2002**, 238
131. J. G. Cook, Handbook of Textile Fibres, Man-Made Fibres, part-II, Merrow Publ. Co., England, **1993**
132. R. H. Peters, The Chemistry of Fibres, vol. 1, Elsevier Publ. Co., Amsterdam, **1963**
133. M. Rabe, Ph. D. Dissertation, Technical University of Dresden, **1999**
134. A. J. Rigby, Textile Horizons, 13/6, **1993**, 42
135. H. P. Gysin, Textilveredlung, 28, **1993**, 101
136. W. Naßl, L. Schreiber, F. Dirschal, Melliand Textilberichte, 4, **2002**, 243
137. R. E., Weiltgen, Textilveredlung, 21, **1986**, 384
138. J. Höpken, Dissertation, University of Twente, Netherlands, **1991**
139. K. Poppenwimmer, J. Schmidt, Textilveredlung, 5/6, **1999**, 4
140. A. J. Sabia, Text. Chem. and Colorist, August, **1994**, 13
141. Anonym, Chemiefasern/Textilindustrie, 38, **1988**, 90
142. L. Schreiber, Melliand Textilberichte, 10, **2002**, 750
143. Technical Bulletin, Rotta GmbH, Mannheim
144. K. Kosswig, H. Stache, Die Tenside, Carl Hanser-Verlag München, **1993**
145. N. R. S. Hollies, M. M. Kaessinger, H. Bogaty, Text. Res. J., 26, **1956**, 829
146. V. Rossbach, Lecture Sheet, Textile Finishing, TU Dresden, **2000**
147. W. G. Cutler, R. C. Davis, Detergency, part 1, Interscience Publ., NY, **1972**

148. R. Haupt-Stephan, *Textilveredlung*, 32, **1997**, 161
149. G. W. Madaras, *JSDC*, 74, **1958**, 835
150. J. Scheirs, *Polymeric Materials Encyclopedia*, 4, **1996**, 2498
151. Y. Ono, *Dyeing Ind.*, 30, **1982**, 460
152. L. Cerene, B. Simoncic, *Text. Res. J.*, 74(5), **2004**, 426
153. Y. Ono, *Dyeing Ind.*, 30, **1982**, 460
154. W. Chen, Y. Fadeev et al., *Langmuir*, 15, **1999**, 3395
155. A. F. Thünemann, *Langmuir*, 16, **2000**, 824
156. N. Ogawa, M. Soga, Y. Takada, I. Nakayama, *J. Appl. Phys.*, 32, **1993**, 614
157. W. Achwal, *Man-Made Textiles India*, April, **1984**, 185
158. A. Bendak, S. M. EL-Marsafi, *J. Islamic Academy of Sci.*, 4, **1991**, 275
159. J. P. Youngblood, T. J. McCarthy, *Macromolecules*, 32, **1999**, 680
160. J. Hopkins, J. P. S. Badyal, *J. Phys. Chem.*, 99, **1995**, 4261
161. Y. Lin, H. Yasuda, *J. Appl. Polym. Sci.*, 60, **1996**, 2227
162. J. Wang, D. Feng, H. Wang, M. Rembold, F. Thommen, *J. Appl. Polym. Sci.*, 50, **1993**, 585
163. R. Agostino, F. Cramarossa, S. DeBenedicitis, *Plasma Chem. Plasma Process*, 2, **1982**, 213
164. P. M. Rahmati, F. Arefi, J. Amouroux, *Surface and Coatings Technol.*, 45, **1991**, 369
165. E. Wolfram, R. Faust, *Wetting, Spreading and Adhesion*, Academic Press, London, **1978**
166. J. Kim, C.J. Im, *IEEE Conference on MEMS, Las Vegas, IEEE*, **2002**
167. T. Yasuda, T. Okuno, K. Yoshida, H. Yasuda, *Polym. Mater. Sci. Eng.*, 56, **1987**, 240
168. H. Yasuda, A. K. Sharma, T. Yasuda, *J. Polym. Sci.: Polym. Chem.*, 19, **1981**, 1285
169. T. Yasuda, K. Yoshida, T. Okuno, H. Yasuda, *J. Polym. Sci.*, 26, **1988**, 2061
170. L. Zhang, W. S. Chin, W. Huang, J. Q. Wang, *Surf. Interface Anal.*, 28, **1999**, 16
171. N. Inagaki, S. Tasaka, Y. Takami, *J. Polym. Sci.*, 41, **1990**, 965
172. Q. Hongjin, S. Kunyan, M. Zhaoli, W. Dong, S. Xiquan, L. Jianjun, *Text. Res. J.*, 72(2), **2002**, 93
173. U. D. Hölzdörfer, *Textilveredlung*, 7/8, **2001**, 5
174. R. Thomas, R. Trifilet, *Macromolecules*, 12, **1979**, 1197
175. T. Yasuda, K. Yoshida, T. Okuno, H. Yasuda, *J. Polym. Sci.: Polym. Phys.*, 26, **1988**, 2061
176. A. Holländer, 11. Neues Dresdner Vakuumtechnisches Kolloquium, 16-17 October, **2003**
177. E. R. McCall, S. H. Miles, R. T. O'Connor, *Am. Dye Stuff Reporter*, 55, **1966**, 31
178. N. J. Harrick, *Internal Reflection Spectroscopy*, John Wiley & Sons, NY, **1967**

179. Technical Bulletin, Beaglehole Instruments, Wellington New Zealand, **2001**
180. R. M. A. Azzam, N. M. Bashara, *Ellipsometry and Polarized Light*, vol. 2, North Holland Press, **1987**
181. J. W. Coburn, H. F. Winters, T. J. Chguang, *J. Appl. Phys.*, 48(8), **1977**, 3532
182. I. H. Lo, M. Klausner, R. F. Baddour, R. E. Cohen, *Polym. Eng. Sci.*, 27, **1987**, 861
183. J. C. Salamone, *Polymeric Materials Encyclopedia*, 4, **1996**, 2515
184. T. A. Brennan, *The new England J. Med.*, 324, **1991**, 1504
185. L. Thiele, J. E. Diederichs, R. Reszka, H. P. Merkle, E. Walter, *Biomaterials*, 24, **2003**, 1409
186. J. M. Matthews, *Textile Fibres*, John Wiley & Sons, NY, **1945**
187. M. Malmsten, *Biopolymers at Interfaces*, 75, **1998**, 519
188. W. Norde, *Macromol. Symp.*, 103, **1996**, 5
189. F. A. Denis, P. Hanarp, D. S. Sutherland, et al., *Langmuir*, 18, **2002**, 819
190. G. B. Sigal, M. Mrksich, G. M. Whitesides, *J. Am. Chem. Soc.*, 120, **1998**, 3464
191. Y. D. Dufrene, T. G. Marchel, P. G. Rouxhet, *Langmuir*, 15, **1999**, 2871
192. A. Schuetz, J. D. Roback, *Expert Review of Anticancer Therapy*, 1(2), **2003**, 267
193. J. McCullough, *Clin. Infect Dis.*, 37(1), **2003**, 88
194. A. M. Suontaka, O. Akerblom, M. Blombäck, L. Eriksson, C. F. Högman, J. M. Payrat, *Vox Sanguinis*, 71(2), **1996**, 97
195. J. M. Harris, N. Abramson, *American Family Physician*, 56(6), **1977**, 1591
196. S. Rainer, *Das Blut*, 1, **1989**, 14
197. Technical Bulletin, Lauffenmühle GmbH, Germany
198. Technical Bulletin, Bayer AG, Germany
199. Technical Bulletin, Krüss GmbH, Germany
200. L. J. Gerenser, in *Plasma Surface Modification of Polymers*, M. Strobel, C. S. Lyons, K. L. Mittal (ed.), VSP Utrecht, Netherlands, **1994**
201. D. Pleul, F. Simon, 10. Neues Dresdener Vakuumtechnisches Kolloquium, **2002**
202. G. Beamson, D. Briggs, *High Resolution of Organic Polymers*, John Wiley & Sons, NY, **1992**
203. A. Woollam, B. Johs, C. M. Herzinger, J. N. Hilfiker, R. Synowicki, C. Bungay, *SPIE Proceedings*, CR72, **1999**, 29
204. R. M. A. Azzam, *SPIE Milestone Series*, MS, 27, **1991**
205. J. D. Jackson, *Classical Electrodynamics*, John Wiley & Sons, NY, **1962**
206. R. W. Richards, S. K. Peace, *Polymer Surfaces and Interfaces III*, John Wiley & Sons, **1999**
207. G. H. Bu-Abbud, S. A. Alterovitz, N. M. Bashara, J. A. Woollam, *J. Vac. Sci. Technol.*, A1, **1983**, 619

208. K. Yagi, *Int. Appl. Cryst.* 20, **1987**, 147
209. Technical Bulletin, LEO GmbH, Germany
210. S. H. Amirshahi, M. T. Pailthorpe, *Textile Res. J.* 64(6), **1994**, 357
211. J. Alvarez, B. L.-Symonowicz, *AUTEX Research Journal*, 3(2), **2003**, 72